

*Instruction manual for rescue equipment*

*eDRAULIC spreader*

---

SP 333 E2



SP 555 E2  
SP 777 E2

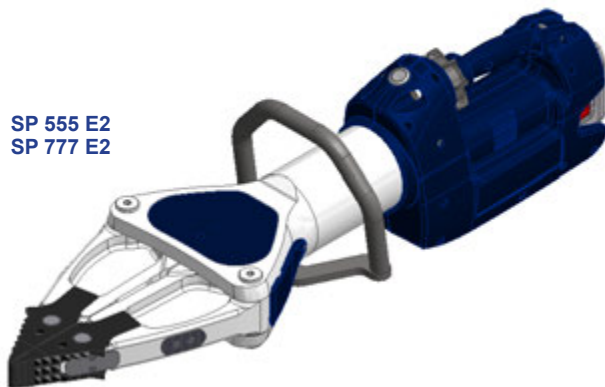

271333085 EN  
Edition 09.2019  
*replaces 11.2018*

# Content



# Page

1. Danger classifications	4
2. Product safety	5
3. Proper use	9
4. Functional description	11
4.1 <i>Description</i>	11
4.2 <i>Unit in detail</i>	12
4.3 <i>Hydraulic circuit diagram</i>	13
4.4 <i>Operating movement controls</i>	13
5. Operation	13
5.1 <i>Battery or power supply for eDRAULIC device</i>	13
5.2 <i>Operating the star grip</i>	14
6. Spreading, pulling, squeezing and peeling	15
6.1 <i>Safety notes</i>	15
6.2 <i>Spreading</i>	16
6.3 <i>Pulling</i>	17
6.4 <i>Squeezing</i>	18
6.5 <i>Peeling</i>	19
7. Dismantling the equipment / deactivation following operation	20
8. Maintenance and service	21
8.1 <i>Oil change</i>	21
8.2 <i>Overview of eDRAULIC spreader</i>	22
8.3 <i>Protective equipment</i>	23
8.4 <i>Checking the filter in the battery shaft</i>	23
9. Repairs	24
9.1 <i>General information</i>	24
9.2 <i>Preventive service</i>	24
9.3 <i>Repairs</i>	25

<b>Content</b>	<b>Page</b>
10. Troubleshooting	32
11. Technical data	34
11.1 <i>eDRAULIC spreader</i>	35
11.2 <i>Peeling</i>	37
11.3 <i>Noise emission (based on standard EN ISO 3744)</i>	37
11.4 <i>Operating and storage temperature ranges</i>	37
11.5 <i>Oscillation / vibration</i>	37
12. Accessories	38
12.1 <i>Batteries</i>	38
12.2 <i>Battery charger</i>	39
12.3 <i>Power supply</i>	39
12.4 <i>Chain sets</i>	40
13. Instructions regarding disposal	40
14. Notes	41

# 1. Danger classifications

We differentiate between various different categories of safety instructions. The table shown below provides an overview of the assignment of symbols (pictograms) and signal words to the specific danger and the possible consequences.

Pictogram	Damage / injury to	Keyword	Definition	Consequences
	Persons	DANGER!	Immediate danger	Death or severe injury
		WARNING!	Potentially dangerous situation	Potential death or serious injury
		CAUTION!	Less dangerous situation	Minor or slight injury
	Property	ATTENTION!	Risk of damage to property/ environment	Damage to the equipment, damage to the environment, damage to surroundings
	-	NOTE	Handling tips and other important/ useful information and advice	No injury/damage to persons/ environment/ device



Wear a helmet with a face guard.



Wear protective gloves.



Wear safety shoes.



Proper recycling



Protect the environment.



Read and follow the operating instructions.

## 2. Product safety

HURST products are developed and manufactured to ensure the best performance and quality when used as intended.

The safety of the operator is the most important consideration in product design. Furthermore, the operating instructions are intended to help you use HURST products safely.

The generally applicable legal and other binding regulations pertaining to the prevention of accidents and protection of the environment apply and are to be complied with in addition to the operating instructions.

The equipment, including accessories, may only be operated by persons familiar with this Instruction Manual and with appropriate training in the safety aspects of such equipment, otherwise, there is a risk of severe injury or death.

All operators should carefully read and follow this Instruction Manual and the Akku Power GmbH Safety Instructions for eDRAULIC batteries, including all warnings, cautions and information contained therein before they attempt to use or maintain the equipment or its accessories. Do not attempt to utilize or maintain the equipment, including any accessories, unless you have a qualified trainer show you how to safely and properly use this equipment. The use and operation of the HURST Rescue equipment which is powered by lithium-ion batteries must comply with the Akku Power GmbH Safety Instructions for eDRAULIC batteries which are included with the batteries.

To safely operate or maintain the equipment, including accessories, you must read and follow this Instruction Manual and all accessory manuals, in addition to receiving the appropriate safety training.



**WARNING / CAUTION!**























The operating instructions for accessories must be followed!



























**WARNING / CAUTION!**

Please ensure that the accessories you use are appropriate for the maximum operating pressure and the performance of the equipment!

	<p>Please ensure that no body parts or clothing are caught between the visibly moving parts (e.g. blade arms).</p>	<p>Working under suspended loads is not permitted where such loads are being lifted only by means of hydraulic or electro-hydraulic devices. If this work is unavoidable, suitable mechanical supports are also required.</p>	
	<p>Wear protective clothing, a safety helmet with visor, protective footwear and gloves.</p>	<p>Inspect the device before and after use for visible defects or damage.</p>	

 	<p>Immediately report any changes that occur (including changes in operating behavior) to the appropriate persons/departments! If necessary, the equipment is to be shut down immediately and secured!</p>	<p>All bolted connections must be checked for leaks and externally visible damage, which must be repaired immediately! Escaping hydraulic fluid can cause injuries and fires.</p>	
 	<p>In the event of malfunction, immediately deactivate the device and secure it. Repair the fault immediately.</p>	<p>Do not carry out any changes (additions or conversions) to the equipment without obtaining the prior approval of HURST.</p>	
 	<p>Observe all safety and danger information on the device and in the operating instructions.</p>	<p>All safety and danger instructions on the device must always be complete and in a legible condition.</p>	 
 	<p>Any mode of operation which compromises the safety and/or stability of the device is forbidden!</p>	<p>Repairs to the equipment may only be carried out by a trained service technician with specific knowledge of the device.</p>	 
 	<p>Safety devices may never be disabled!</p>	<p>Only genuine HURST accessories and spare parts are to be used for repairs.</p>	 
	<p>Before switching on/starting up the device and during its operation, make sure that nobody will be endangered by this.</p>	<p>Observe all intervals for recurring tests and/or inspections that are prescribed or stated in the operating instructions.</p>	
 	<p>When working close to live components and cables, suitable measures must be taken to avoid current transfers or high-voltage transfers to the equipment.</p>	<p>Please note that material could fall down or suddenly break free during spreading, cutting, squeezing operations as a result of shearing, tearing or breaking; appropriate steps must be taken to avoid this.</p>	

 	<p>Please ensure that you do not become entangled in cables and trip when working with or transporting the device.</p>	<p>Please ensure that the battery contacts are not short-circuited.</p>	 
	<p>The build-up of static charges and therefore possible sparking must be avoided when handling the device.</p>	<p>Only touch broken-off or cut-off parts while wearing protective gloves, as the torn / cut edges can be very sharp.</p>	
	<p>The eDRAULIC devices have an IP54 protection class. They are suitable for use in wet weather conditions and are splash proof.</p>	<p>The eDRAULIC devices are not suitable for underwater use.</p>	 
	<p>The equipment is filled with hydraulic fluid. This hydraulic fluid can be detrimental to health if it is swallowed or its vapor is inhaled. Direct contact with the skin must be avoided for the same reason. Also, when handling hydraulic fluid, note that it can negatively affect biological systems.</p>	<p>When working with or storing the equipment, ensure that the function and the safety of the equipment are not impaired by the effects of severe external temperatures and that the equipment is not damaged in any way. Please note that the equipment can also heat up over a long period of use.</p>	
	<p>Make sure that there is adequate lighting while working.</p>	<p>Before transporting the equipment, always ensure that the accessories are positioned in such a way that they cannot cause an accident.</p>	
	<p>Always keep these operating instructions easily accessible at the place of operation.</p>	<p>Ensure the proper disposal of all removed parts, left-over oil and hydraulic fluid as well as packaging materials!</p>	 

 	<p>Do not expose the Akku Power GmbH lithium-ion battery to water, oil, or moisture or liquid of any kind, as this could lead to a battery malfunction resulting in fire causing personal injury or death!</p>	<p>Do not attempt to use the HURST Rescue Equipment with the Akku Power GmbH lithium-ion battery that has been exposed directly or indirectly to water, oil, moisture or liquid of any kind, as this could lead to a battery malfunction resulting in fire causing personal injury or death!</p>	 
 	<p>Do not expose the Akku Power GmbH lithium-ion battery charger to water, oil or moisture or liquid of any kind as this could lead to a battery malfunction resulting in fire causing personal injury or death!</p>	<p>Do not place the Akku Power GmbH lithium-ion battery that has been exposed directly or indirectly to water, oil, moisture or liquid of any kind onto a charger as this could lead to a battery malfunction resulting in fire causing personal injury or death!</p>	 

The generally applicable, legal and other binding national and international regulations pertaining to the prevention of accidents and protection of the environment apply and are to be implemented in addition to the operating instructions.

## WARNING / CAUTION / ATTENTION!

The device is intended **exclusively** for the purpose stated in the operating instructions (see chapter "Proper Use"). **Any other use is not in accordance with its designated purpose.** The manufacturer/supplier is not liable for any damage resulting from improper use. The user bears sole responsibility for such use. Proper use includes observance of the operating instructions and compliance with the inspection and maintenance conditions.



Never work in a fatigued or intoxicated state!





### 3. Proper use

HURST eDRAULIC spreaders have been specially designed to rescue or retrieve the bodies of victims of road, rail or aircraft accidents or to be used during rescue operations from buildings. HURST eDRAULIC spreaders can also be used to free persons who have become trapped by pushing open doors or removing obstacles with the aid of a chain set. During other catastrophic events, spreaders can also be used to move objects to rescue persons who have been buried or trapped.



#### **CAUTION / PLEASE NOTE!**

Care must always be taken that the environment of the object to be processed remains stable and secured against unintentional shifting by using strong supports or underpinning.



#### **WARNING / CAUTION / PLEASE NOTE!**

The HURST eDRAULIC devices and the Akku Power GmbH lithium-ion batteries:

- **ARE NOT** suitable for underwater use
- **ARE NOT** waterproof
- **ARE NOT** water-resistant
- **ARE NOT** liquid- proof or resistant



Do not expose the Akku Power GmbH lithium-ion battery or battery charger to water, oil or moisture as this could lead to a battery malfunction resulting in fire causing personal injury or death!

There have been reports of spontaneous burns and fires igniting from the charging, storage and use of lithium-ion batteries. You must always check that the Akku Power GmbH lithium-ion battery is charging and operating consistently with the battery manufacturer's manual and has not been damaged or exposed to moisture or liquid of any kind.



**WARNING / CAUTION / PLEASE NOTE!**

The following may not be cut / squeezed:



- **live cables**
- **prestressed and hardened parts such as springs, spring steels, steering columns and rollers**
- pipes under gas or liquid pressure,
- compound materials (steel/concrete)
- explosive bodies such as airbag cartridges

The operating pressure placed on the rescue device may only be directly changed after consultation with HURST. A change in settings may result in damage to property and/or injuries.

HURST eDRAULIC devices are **not** explosion-protected!

When using the devices in potentially explosive environment, **the following** must be excluded:

- that the device could trigger an explosion.
- that working with the device could trigger an explosion; e.g. sparks may result from cutting an object.

The responsibility for explosion prevention or for ruling out work with an eDRAULIC device with the operator of the device or with the person responsible at the place of use.

**When working in areas at risk of explosion, all applicable legal, national and international regulations, standards and safety rules for avoiding explosions must be observed without restriction!**

The rescue equipment should not come into contact with acids or alkalines. If this is unavoidable, clean the equipment immediately afterwards with a suitable cleaning agent.

You can obtain accessories and replacement parts for the rescue devices from your authorized HURST dealer!

## 4. Functional description

### 4.1 Description

The spreaders have been designed in such a way that a hydraulically operated piston activates mechanical joints symmetrically to open or close a set of two opposite spreader arms. This movement can be used to spread open, squeeze or pull open objects.

For all devices, the movement is activated by means of a valve in the form of a star grip. All devices guarantee the dead man's switch and the full load-supporting function when the star grip is released.

HURST eDRAULIC devices do not need to be connected to an external hydraulic source (e.g. a motor pump). Generation of the required hydraulic pressure takes place within the body of the device.

Either a battery or an external power supply must be connected as an energy source.

You can choose which energy source you wish to use. Both the accumulator battery and the mains power unit can be inserted into the opening provided in the body of the tool.

They are then automatically locked into position.

You can extend the operating time of your eDRAULIC device by using several batteries.

The batteries can be recharged after use, using a suitable external charger.

If you are making use of an external power supply, the device can be used for an almost unlimited time. This time is only limited by the external energy source and the overheating switch of the power supply.

To allow you to select the best possible energy supply for your eDRAULIC device, neither the battery nor the power supply form part of the delivery scope. You will find suitable batteries and power supplies in the HURST accessories list.

eDRAULIC devices come with standard light fittings to facilitate work under poor light conditions.

The light-emitting diodes attached on the operating side light up the work area. The main switch has also been equipped with a ring light, so that you can immediately detect whether the device is switched on or not. When exchanging the battery or power supply, the connection slot will light up for approximately 30 seconds.

## 4.2 Unit in detail

SP 333 E2  
SP 555 E2  
SP 777 E2

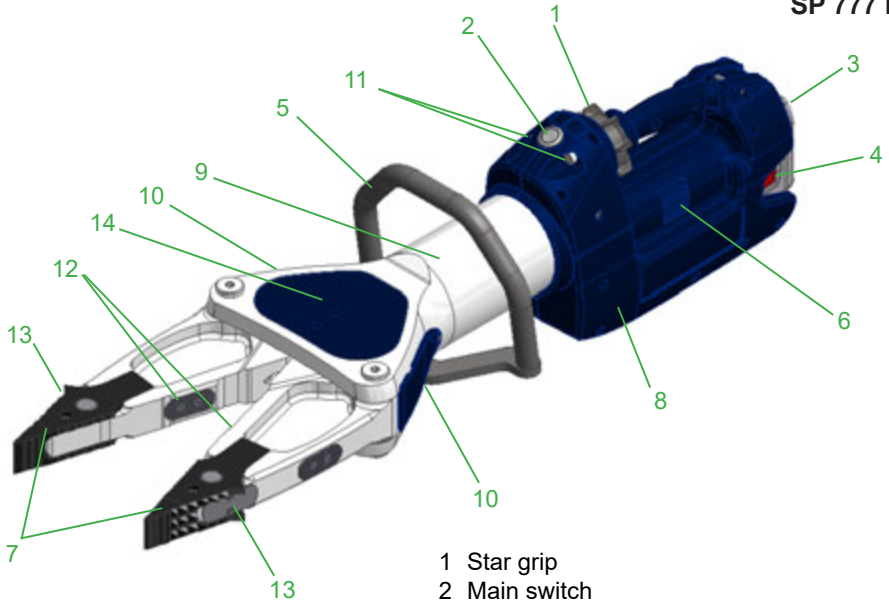

- 1 Star grip
- 2 Main switch
- 3 Quick exchange battery or power supply
- 4 Release button for battery and power supply
- 5 Handle
- 6 Ventilation slots
- 7 Spreader arms with plug-on tips
- 8 Plastic housing
- 9 Tool body
- 10 Protective cover
- 11 Light
- 12 Squeezing device
- 13 Protective plate for spreader arm
- 14 Yoke cover

### 4.3 Hydraulic circuit diagram

To enable comprehension of the function, a simplified hydraulic ram of the rescue equipment (A) + hand valve (B) are depicted here.

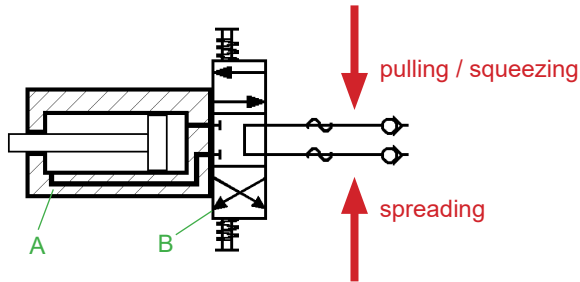

### 4.4 Operating movement controls

The piston movement is controlled by the star grip on the attached valve (see illustration below).



## 5. Operation

### 5.1 Battery or power supply for eDRAULIC device

#### Commissioning

Before initial operation, the battery (where used) of the rescue device must be fully loaded, using the external charger.

Procedure:

1. Unplug the power supply (where used) from the mains.
2. Fully press down the two unlocking buttons and carefully pull the battery or power supply out of the device.

**Do not use force!**

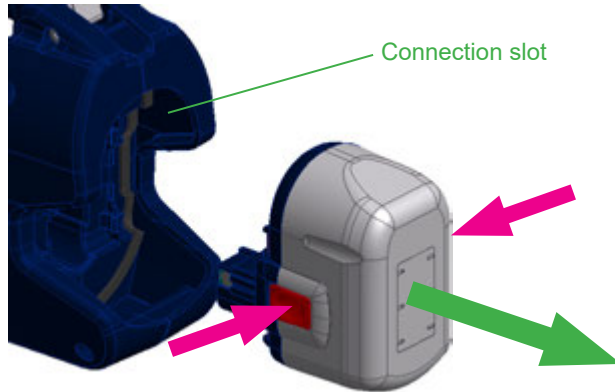

3. The battery can now be recharged in the charger (please take note of the separate operating instructions for the charger and the batteries to be used); alternatively, the power supply can be replaced.
4. Insert the recharged or new battery into the eDRAULIC device until it reaches the stop. The battery or power supply will be automatically locked when correctly operated.

## 5.2 Operating the star grip

(also see chapter on "Operating movement control")

Opening the device (  ):

Turn the star grip in a clockwise direction (in the direction of the relevant symbol) and keep in this position.

Closing the device (  ):

Turn the star grip in an counterclockwise direction (in the direction of the relevant symbol) and keep in this position.



### "Dead-man's" function:

Following release, the star grip automatically returns to the central position, fully guaranteeing load retention.

## Note on the operation of the eDRAULIC with a rechargeable battery:

If the rechargeable battery remains in the eDRAULIC device with the main switch on, but without activating the star grip, the rechargeable battery will switch itself off after some time (approximately 10 - 60 minutes, depending on the type of battery). If the star grip is then activated, the eDRAULIC device will not switch itself on.

In order to resume work with the device, the eDRAULIC device must first be switched off at the mains and then switched on again.

Alternatively, the capacity display on the rechargeable battery can be activated or the battery may be briefly unplugged and replugged again.

# 6. Spreading, pulling, squeezing and peeling

## 6.1 Safety notes

Before rescue work can commence, the object must be stabilized in its current position. Ensure that the objects to be worked on are adequately underpinned and/or supported to ensure that there is no risk of sliding or shifting.

Worldwide safety guidelines pertaining to the specific country must be observed and complied with. In the Federal Republic of Germany, regular safety inspections according to the regulations of the Gesetzlichen Unfallversicherung (GUV; 'Legal accident insurance') are mandatory.



### **WARNING / CAUTION / PLEASE NOTE!**

HURST eDRAULIC devices are **not** explosion-protected!



When using the devices in potentially explosive environments, **the following** must be excluded:

- that the device could trigger an explosion.
- that working with the device could trigger an explosion; e.g. sparks may result from cutting an object.

The responsibility for explosion prevention or for ruling out work with an eDRAULIC device lies with the operator of the device or with the person responsible at the place of use.

**When working in areas at risk of explosion, all applicable legal, national and international regulations, standards and safety rules for avoiding explosions must be observed without restriction!**

The following are to be worn when working with the rescue equipment:

- protective clothing,
- safety helmet with visor or protective goggles,
- protective gloves
- and, if necessary, ear protection



Before operating the rescue device, you should ensure that no participants or bystanders are at risk from the movements of the rescue device or from flying fragments! Avoid unnecessary damage to property belonging to others or to objects not involved in the rescue or damage caused by flying fragments.



It is strictly prohibited to reach into the path of the rescue device (e.g. between the spreader arms and the material/object to which the force is to be applied)!



**CAUTION / PLEASE NOTE!**

The strong effect of the force of the rescue equipment during operation could cause pieces of the vehicle to break off or fly off, posing a danger to persons. Those not involved in the rescue operation should therefore keep at a **safe distance appropriate to the situation**. Any trapped or enclosed persons must be protected.

## 6.2 Spreading

Use the front of the tips only to increase an existing gap. To increase grip and to avoid having the tips slip or break out of the part to be processed, the grip should be reapplied at an early stage. The highest force develops in the rear area of the plug-on tip.



**WARNING / CAUTION / PLEASE NOTE!**

The light metal alloy spreader arms may not be damaged.



The spreaders have additional exchangeable plates to protect the arms against physical damage.

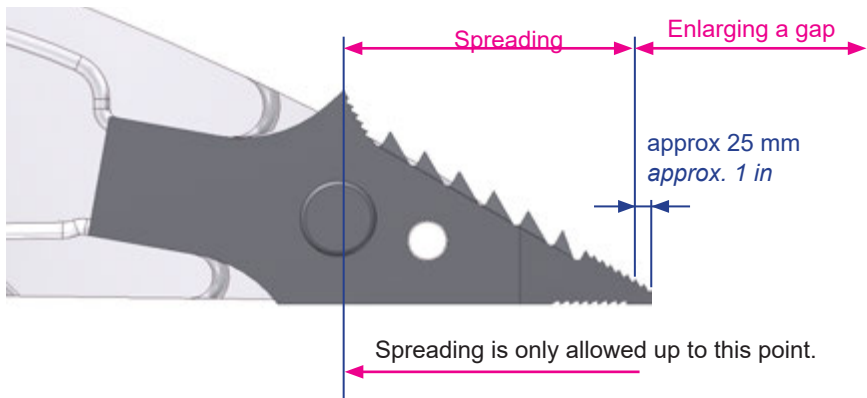



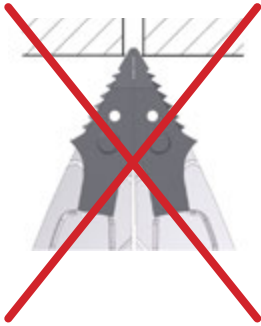

Working surface is too small, tips slip off. Only for increasing the size of a gap (not suitable for spreading)

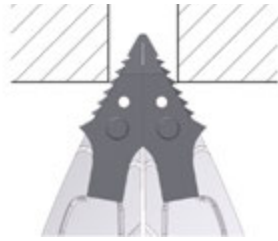

Tips get a safe grip.



Only work with the tips, so that the spreader is not damaged in the area of the light metal arms.

### 6.3 Pulling



**WARNING / CAUTION / PLEASE NOTE!**



The light metal alloy spreader arms may not be damaged.

- HURST chain sets must be used for pulling.
- When using a chain for pulling, make sure that the pins and hooks are positioned correctly so that the chain cannot slip.
- Only chain sets in perfect condition may be used.
- The pulling chains must be checked by an expert at least once a year.
- Also consult the separate operating instructions for the corresponding chain set!

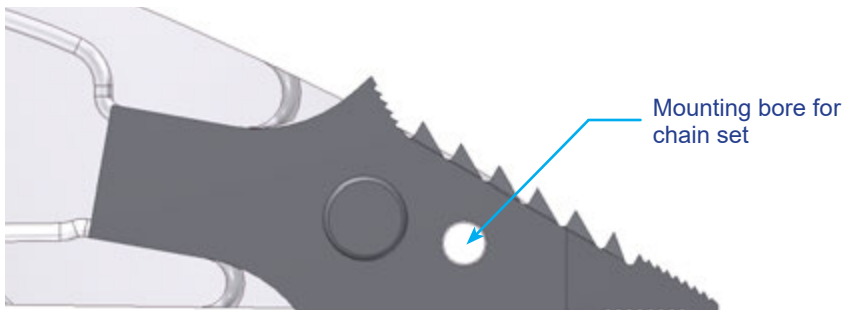

The connecting pieces for HURST chain sets are fastened to the blades using load bolts in holes "A". (see illustration on the right)

Permissible Chain sets:

for SP 333 E2: KSV 11

for SP 555 E2: KSV 11

for SP 777 E2: KSV 11

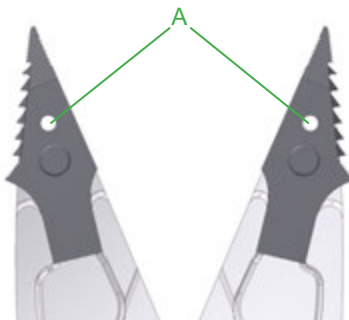

**NOTE:**

Also take note of all the instructions and regulations in the separately provided operating instructions for the chain sets.

## 6.4 Squeezing

Squeezing is allowed

- In the area of the tips.

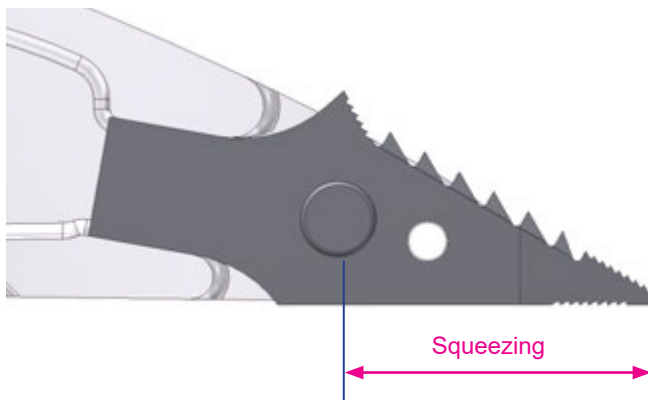

- With the special squeezing plates „A“ in the arms.

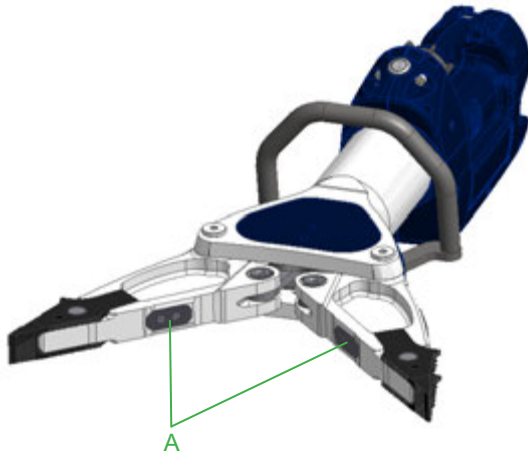

## 6.5 Peeling

It is possible to peel sheet steel with the optional peeling tips of the spreader (max. panel thickness  $t$ , see chapter “Technical Data”).

The spreader tip must be replaced with the peeling tip “A”, see 9.3.1 Tip changing.

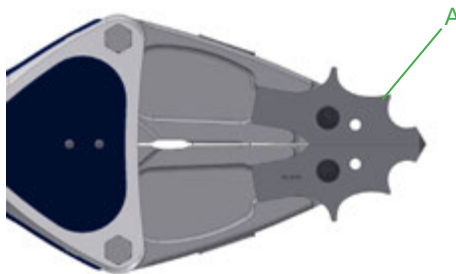



**WARNING / CAUTION!**

With particularly hard materials, chips may break out in an uncontrolled manner. Please maintain the safety distance!

## 7. Dismantling the equipment / deactivation following operation

Once work has been completed, the device arms should be closed until the tips are only a few millimeters apart. This relieves the hydraulic and mechanical strain on the equipment.



**NOTE:**

Never store the eDRAULIC devices with fully closed arms! By fully closing the arms hydraulic and mechanical tension may develop in the device.

Clean the rescue device after each operation and grease both the metallic and the mechanically movable parts. The lock of the spreader plug-on tips should also be greased from time to time.

Greasing provides protection against excessive wear and tear or corrosion.

Avoid storing the rescue equipment in a damp environment.

## 8. Maintenance and service

The devices are subject to very high mechanical stresses. A visual inspection must therefore be carried out after every use and at least one visual inspection must be carried out every six months. These inspections enable the early detection of wear and tear, which means that punctual replacement of these wearing parts prevents breakage.

An annual inspection of the tool is due once a year. This inspection must be performed by a person with the necessary expertise. This means that the person must possess adequate specialist knowledge and experience in the fields of electrical engineering and hydraulics, so that they can objectively assess the condition of the tool.

Every 3 years or when there might be doubts regarding the safety or reliability of the unit, an additional function check is to be carried out (complying with the applicable national and international regulations for the maintenance intervals of rescue equipment). In the Federal Republic of Germany, regular safety inspections according to the regulations of the Gesetzlichen Unfallversicherung (GUV; 'Legal accident insurance') are mandatory.



### **ATTENTION!**

Clean off any dirt before checking the equipment!



### **WARNING / CAUTION / PLEASE NOTE!**

To perform maintenance and repairs, personal safety equipment appropriate for the work is a mandatory requirement.



The maintenance and repair staff must have adequate technical and specialized knowledge. HURST offers appropriate training courses for this.

### 8.1 Oil change

Under normal working conditions routine oil changes are not necessary with eDRAULIC tools.

The prerequisite is that:

- the tools are always properly handled and stowed as per the applicable operating manual
- the tools are tested on a regular basis as per our instructions on preventive maintenance
- after 10 years service life an oil change is recommended

Regular tests, oil change and/or repairs must be carried out by repair and maintenance personnel that is trained and authorized by the manufacturer.

## 8.2 Overview of eDRAULIC spreader

### Inspections to be carried out:

#### *Visual Inspection*

##### *Spreader*

- Opening width of arms at the tips (see chapter on "Technical Data"),
- General tightness (leaks),
- Operability of the star grip - check the automatic return into middle position after release (dead man's function),
- Existence and stability of handle,
- Labels complete and legible,
- Covers in perfect condition,
- Spreader arms not cracked,
- Pins and retaining rings on the spreader arms are present and in a proper condition,
- Corrugation of the tips clean and well-edged, no tears.
- The tips must be in place and locked
- Illumination of main switch, work area and connection shaft fully functional.

##### *Battery and power supply*

- Casing undamaged
- Electrical contact surfaces clean and undamaged
- Cable undamaged
- Battery(-ies) fully charged (when used)
- Charging state display of lithium-ion battery or batteries fully functional
- The battery has not been exposed to water, oil or moisture
- There are no signs that the battery has been damaged or that it is malfunctioning or operating inconsistently with Akku Power GmbH Safety Instructions for eDRAULIC batteries which are included with the batteries

##### *Functional test*

- Easy opening and closing of star grip controls,
- No unusual noises
- No further movement of spreader arms when interrupting the valve function during the process (dead man's switch).

## 8.3 Protective equipment

### Inspections to be carried out:

- Check the protective equipment used on / in the vicinity of the rescue device. Pay particular attention to the protective cover for the movable parts (there may be no cracks!).

## 8.4 Checking the filter in the battery shaft

The air suction filter is to be checked at least once a year or after use in a dusty environment. The filter can be checked from the outside if the mains unit (or battery) is removed (see illustrations below).

If the filter is severely contaminated, it will need to be replaced.

### Procedure:

1. Tilt the respective device as shown in the illustration.
2. Remove the battery or the power supply.
3. Remove the filter grid by activating the release hook.
4. Replace the dirty filter elements with new filter elements.

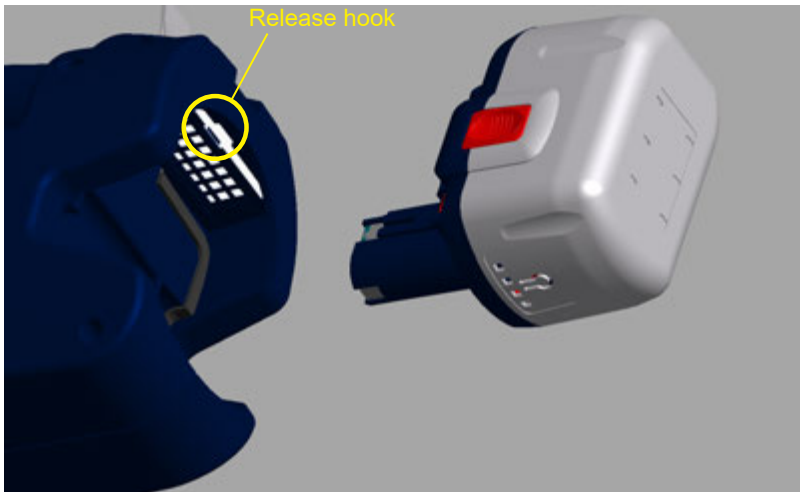

# 9. Repairs

## 9.1 General information

Service work may only be performed by the device manufacturer or by personnel trained by the device manufacturer and authorized HURST dealers.

Only HURST spare parts may be used to replace all components (see spare parts list), as special tools and compliance with, assembly instructions, safety aspects and inspections are required (see also chapter "Maintenance and Servicing").

**During assembly, ensure that all components are particularly clean, as dirt can damage the rescue equipment!**



### **WARNING / CAUTION / PLEASE NOTE!**

Protective clothes must be worn when repairs are being carried out, as the devices may also be pressurized when not in operation.



### **NOTE:**

Always register your tool on the HURST Hydraulik GmbH internet site. This is the only way to guarantee extended warranty cover.



### **ATTENTION!**

Because HURST rescue devices are designed for highest performance, only components specified in the spare parts list for the appropriate equipment may be replaced.

Other components in the device may only be replaced if:

- You have participated in an appropriate HURST service training course.
- You have been explicitly granted permission by HURST Customer Service (valid HURST certificate required!)



### **ATTENTION!**

When cleaning units and equipment, note that no cleaning agent may be used that has a pH value outside the range 5 - 8!

## 9.2 Preventive service

### 9.2.1 Care instructions

The outside of the device should be cleaned with a damp cloth from time to time (**not the electrical contacts in the connection slot, on the battery and on the power supply**). In addition, the metal surfaces are to be coated with a suitable medium to counteract corrosion (**not the electrical contacts in the connection slot, on the battery and on the power supply**).

*(In case of doubt, contact your authorized HURST dealer or HURST directly!)*



## 9.2.2 Function and load test

If there is any doubt regarding the safety or reliability of a device, a function and stress test must also be performed.

HURST offers appropriate test equipment for this.

## 9.3 Repairs

### 9.3.1 Replacing the plug-on tips

*Procedure:*

1. In order to remove the plug-on tips “G”, you need to push the buttons “J” on both sides of a spreader arm completely and simultaneously and then remove the plug-on tip from the spreader arm by pulling it forwards.
2. Place the new tips onto the arm until they automatically click in place on the spreader arm.

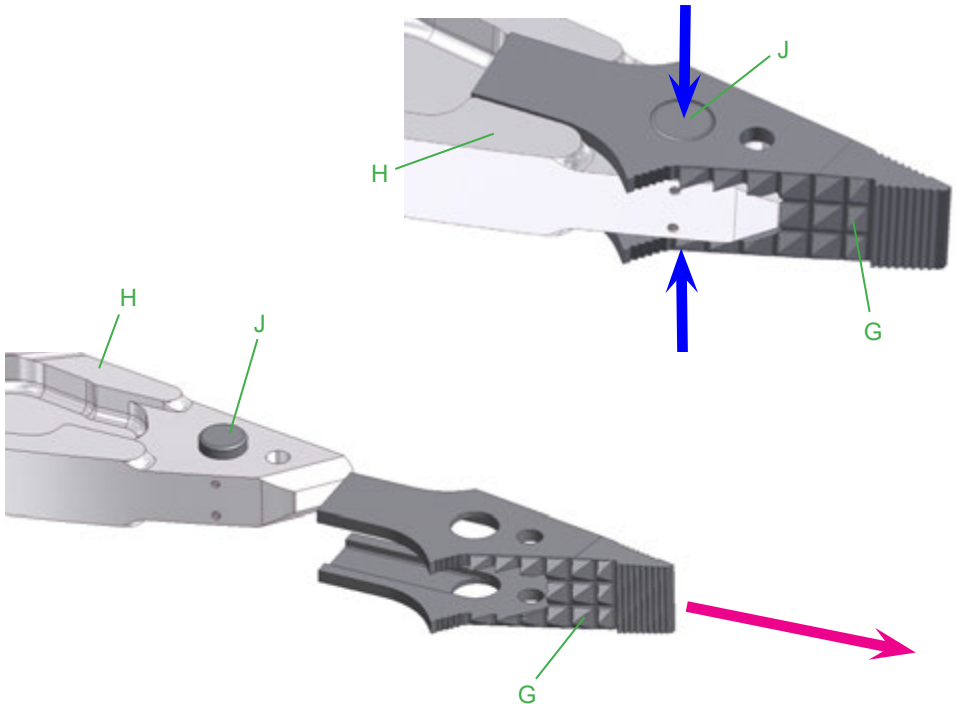

#### **NOTE:**

Always replace both plug-on tips.

When inserting the new tips, push both buttons “J” until the tip can be slid over them.

After fitting, make sure that both buttons “J” are locked on each arm (that they are back in their original position).

### 9.3.2 Replacing the handle

1. Close the rescue unit until a gap of only a few mm remains between the tips. Now switch off the device and remove the battery or unplug the power supply from the device. Clean the rescue equipment carefully.
2. Remove the fixing screws "A" and remove the top section of the handle "B".

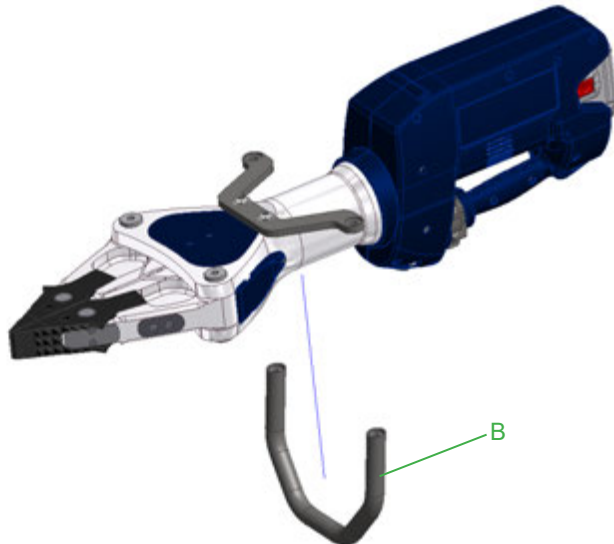
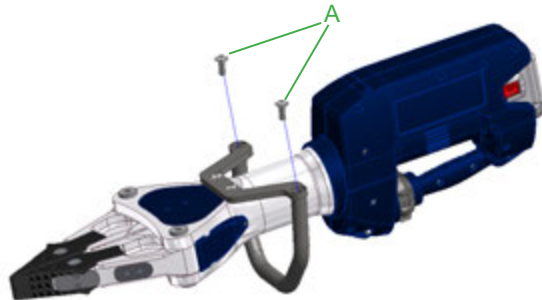

3. Remove the fixing screws “C” and remove the bottom section of the handle “D”.

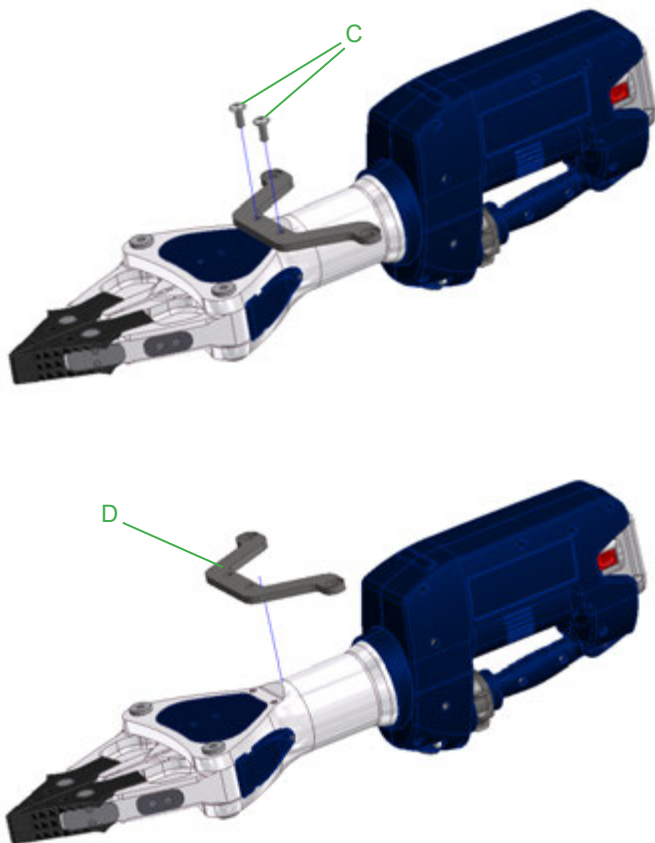

4. Attachment of the handle takes place in the reverse sequence.



**NOTE:**

The torque required can be taken from the spare parts list of your particular unit.

### 9.3.3 Replacing the yoke cover

1. Remove the fixing screws "A" and remove the yoke cover "B".

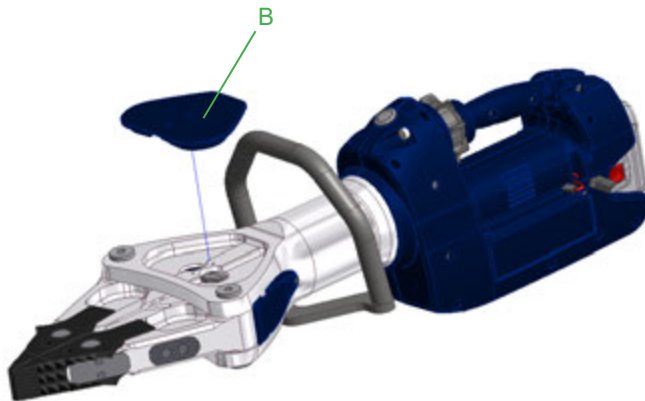
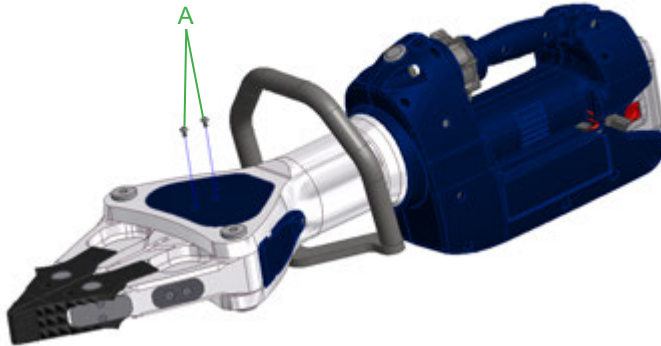

2. Install the new yoke cover.

### 9.3.4 Replacing the squeezing plates

1. Completely open the rescue equipment. Now switch off the device and remove the battery or unplug the power supply from the device. Clean the rescue equipment carefully.
2. Remove the fixing screws "A" and remove the squeezing plates "B".

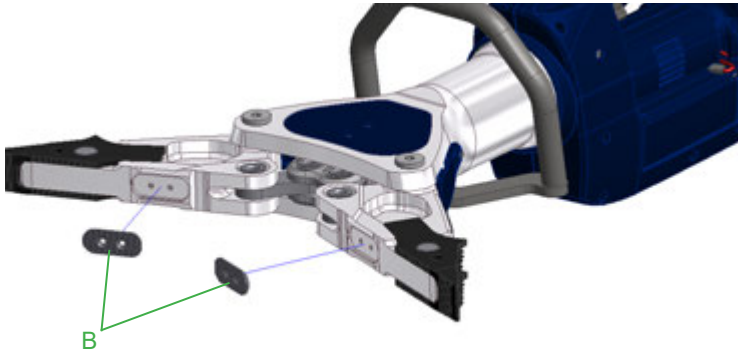
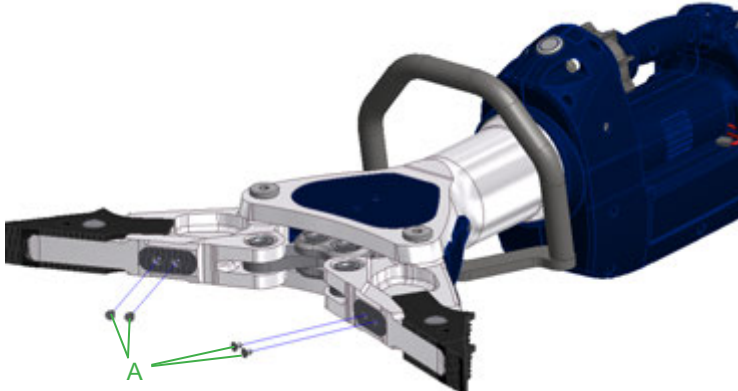

3. Install the new squeezing plates.

### 9.3.5 Replacing the protective plates

1. Close the rescue unit until a gap of only a few mm remains between the tips. Now switch off the device and remove the battery or unplug the power supply from the device. Clean the rescue equipment carefully.
2. Remove the fixing screws "A" and remove the protective plates "B".

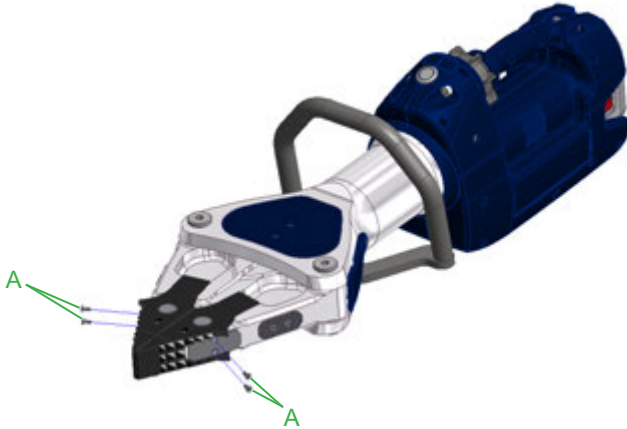

3. Install the new protective plates.

### 9.3.6 Replacing the protective covers

1. Remove the fixing screws "A" and remove the protective covers "B" using an appropriate tool.

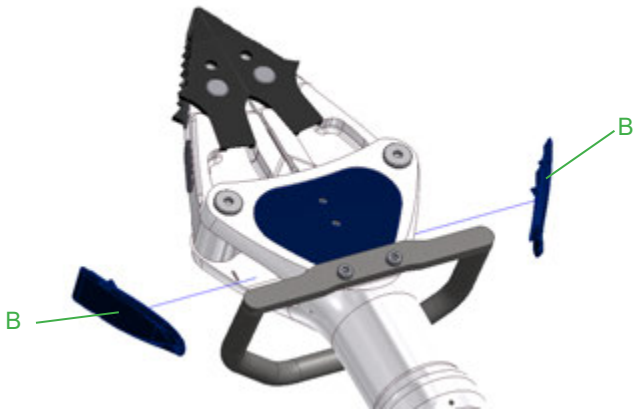
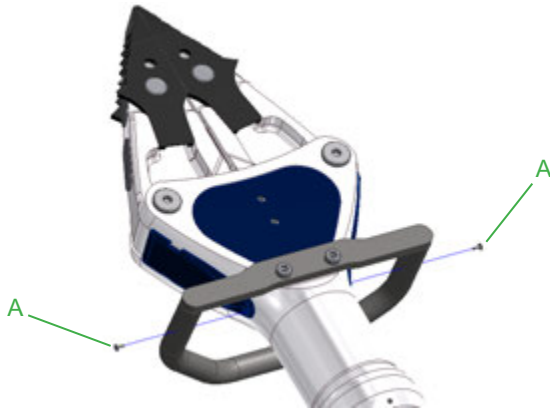

2. Install the new protective covers.

## 10. Troubleshooting

Fault	Check	Cause	Solution
The motor does not start after activating the star grip.	The main switch is not illuminated, although it has not been switched off.	The star grip was not used for some time (at least 10 minutes) during battery operation. The rechargeable battery has switched itself off.	In order to resume work with the device, the eDRAULIC device must first be switched off at the mains and then switched on again. Alternatively, the capacity display on the rechargeable battery can be activated or the battery may be briefly unplugged and replugged again.
Spreader arms move slowly or jerkily when operated	Battery fully charged?	Battery flat	Charge battery
		Battery defective	Replace battery
		Air in the hydraulic system	Repair by an authorized dealer, by personnel specially trained by HURST, or by HURST itself
	Power supply cable connected?	Power supply not properly connected to the eDRAULIC device (not automatically locked).	Reinsert power supply into the connection shaft.
		Power supply cable not properly connected to the external power supply.	Reconnect external power supply.
		Power supply or power supply cable defective.	Replace power supply or power supply cable.
		External power source defective.	Use other external power source



<b>Fault</b>	<b>Check</b>	<b>Cause</b>	<b>Solution</b>
Spreader arms do not move when operated.	Battery fully charged?	Battery flat	Charge battery
		Battery defective	Replace battery
	Power supply cable connected?	Power supply cable defective	Replace power supply cable
		Device defective	Repair by an authorized dealer, by personnel specially trained by HURST, or by HURST itself
Device doesn't perform at its given power		Device defective	Repair by an authorized dealer, by personnel specially trained by HURST, or by HURST itself
Following release, the star grip doesn't return to the central position	Casing damaged or star grip operation not working smoothly?	Damage to the torsion spring for reset	Repair by an authorized dealer, by personnel specially trained by HURST, or by HURST itself
		Soiled valve or star grip	
		Defective valve	
		Other mechanical damage (e.g. star grip)	
Hydraulic fluid leaking from the piston rod		Defective rod seal	Repair by an authorized dealer, by personnel specially trained by HURST, or by HURST itself
		Damage to the piston	
The useful operating time between the individual charging cycles is less than 5 minutes, despite charging the batteries according to the instructions.		Battery defective	Replace battery

Contact an authorised HURST dealer or the HURST Customer Service Department directly if the malfunctions cannot be rectified.

The address for the HURST Customer Service department is:

**HURST JAWS OF LIFE, INC**  
*A Unit of IDEX Corporation*

711 N. Post Road  
Shelby, NC 28150 USA  
Phone: (704) 487-6961  
Fax: (704) 487-7271  
e-mail: [contacthurst@idex.com](mailto:contacthurst@idex.com)

## 11. Technical data

Since all values are subject to tolerances, minor differences may occur between the data on your equipment and the data in the following tables.

The values may also differ because of reading inaccuracies and/or tolerances in the measuring equipment used.



**NOTE:**

The following tables contain only the technical data necessary for operation and storage.

Further information about your device is available directly from HURST.

<b>Operating pressure:</b>	SP 333 E2:	70 MPa
	SP 555 E2:	70 MPa
	SP 777 E2:	70 MPa

## 11.1 eDRAULIC spreader

Device type		SP 333 E2	SP 555 E2
Item number		271333000	271555000
Dimensions (excluding battery) L x W x H	[mm] [in.]	905 x 255 x 285 <i>35.6 x 10.0 x 11.2</i>	1002 x 265 x 280 <i>39.4 x 10.4 x 11.0</i>
Minimum spreading force (at a distance of 25 mm / 0.98 inches from the tips)	[kN] [lbf.]	42 <i>9442</i>	52 <i>11690</i>
Max. possible spreading force *	[kN] [lbf.]	836 <i>187940</i>	658 <i>147924</i>
LSF spreading force (according to NFPA)	[kN] [lbf.]	39 <i>8768</i>	49 <i>11016</i>
HSF spreading force (according to NFPA)	[kN] [lbf.]	63 <i>14162</i>	72 <i>16186</i>
Maximum spreading path	[mm] [in.]	600 <i>23.6</i>	730 <i>28.7</i>
Maximum pulling force (with appropriate chain set)	[kN] [lbf.]	56 <i>12589</i>	58 <i>13039</i>
Pulling path (with appropriate chain set)	[mm] [in.]	440 <i>17.3</i>	569 <i>22.4</i>
HPF pulling force (according to NFPA)	[kN] [lbf.]	43 <i>9667</i>	46 <i>10341</i>
LPF pulling force (according to NFPA)	[kN] [lbf.]	23 <i>5171</i>	28 <i>6295</i>
Mass (excl. battery)	[kg] [lbs.]	17,3 <i>38.1</i>	20,0 <i>44.1</i>
Nominal electrical voltage (with power supply)	[V]	25,2	25,2
Nominal electrical voltage (with lithium-ion battery)	[V]	25,2	25,2
Protection category		IP 54	IP 54

\* Computed value

<b>Device type</b>	<b>SP 777 E2</b>	
<b>Item number</b>	271777000	
<b>Dimensions (excluding battery)</b> [mm] L x W x H	[mm]	1075 x 308 x 285
	[in.]	42.3 x 12.1 x 11.2
<b>Minimum spreading force</b> (at a distance of 25 mm / 0.98 inches from the tips)	[kN]	63
	[lbf.]	14160
<b>Max. possible spreading force *</b>	[kN]	600
	[lbf.]	134900
<b>LSF spreading force</b> (according to NFPA)	[kN]	59
	[lbf.]	13260
<b>HSF spreading force</b> (according to NFPA)	[kN]	85
	[lbf.]	19110
<b>Maximum spreading path</b>	[mm]	813
	[in.]	32.0
<b>Maximum pulling force</b> (with appropriate chain set)	[kN]	60
	[lbf.]	13490
<b>Pulling path</b> (with appropriate chain set)	[mm]	655
	[in.]	25.8
<b>HPF pulling force</b> (according to NFPA)	[kN]	49
	[lbf.]	11016
<b>LPF pulling force</b> (according to NFPA)	[kN]	30
	[lbf.]	6744
<b>Mass (excl. battery)</b>	[kg]	24,5
	[lbs.]	54.0
<b>Nominal electrical voltage</b> (with power supply)	[V]	25
<b>Nominal electrical voltage</b> (with lithium-ion battery)	[V]	25,2
<b>Protection category</b>	IP 54	

\* Computed value

## 11.2 Peeling

Device type		SP 333 E2	SP 555 E2	SP 777 E2
Max. sheet steel thickness “t”	[mm]	2	3	4
	[in.]	0.08	0.12	0.16
Max. possible opening	[mm]	510	640	725
	[in.]	20.1	25.2	28.5

## 11.3 Noise emission (based on standard EN ISO 3744)

Device type	SP 333 E2, SP 555 E2, SP 777 E2	
Battery type used for device	Lithium/ion	
Idling (measured at a distance of 1 m, according to EN)	[dB(A)]	74
Full load (measured at a distance of 1 m, according to EN)	[dB(A)]	77
Idling (measured at a distance of 4 m, according to NFPA)	[dB(A)]	69
Full load (measured at a distance of 4 m, according to NFPA)	[dB(A)]	71

## 11.4 Operating and storage temperature ranges

Operating temperature	[°C] / [°F]	-20 ... +55	-4 ... +131
Storage temperature (device not in operation)	[°C] / [°F]	-30 ... +60	-22 ... +140

## 11.5 Oscillation / vibration

The total oscillation value / vibration value to which the upper limbs are exposed, is usually below 2.5 m/s<sup>2</sup>.

Higher values may be measured for short periods as a result of interaction with the materials to be processed.

*(The oscillations / vibrations were determined in accordance with DIN EN ISO 20643.)*

## 12. Accessories

### 12.1 Batteries

Only HURST lithium-ion rechargeable batteries may be used to operate eDRAULIC devices. These guarantee optimum performance and maximize the operating time of the eDRAULIC devices.



**NOTE:**

Pay strict attention to the separate Akku Power GmbH Safety Instructions for the batteries, a copy of which is available at [www.jawsoflife.com](http://www.jawsoflife.com)



**NOTE:**

To ensure maximum operating time and maximum uptime, you must make sure that the battery is always fully charged before connecting it to a rescue device.



Technical Data	nom. Voltage	Capacity	Energy	Weight	
Unit	V DC	Ah	Wh	kg	<i>lbs</i>
<b>Battery type 1</b>	25.2	2.6	65	0.92	<b>2.03</b>
<b>Battery type 2</b>	25.2	5.0	126	0.94	<b>2.07</b>

**Battery Type 1: Display code**



Capacity = 75...100% - LED 1-4 lights up

Capacity = 50...75% - LED 1-3 lights up

Capacity = 25...50% - LED 1-2 lights up

Capacity = 0... 25% - LED 1 lights up

**Battery Type 2: Display code**



Capacity = 75...100% - LED 1-4 lights up

Capacity = 62...75% - 4th LED lights up, 1-3 lights up

Capacity = 50...62% - LED 1-3 lights up

Capacity = 37...50% - 3rd LED lights up, 1-2 lights up

Capacity = 25...37% - LED 1-2 lights up

Capacity = 12...25% - 2nd LED lights up, 1 lights up

Capacity = 5... 12% - LED 1 lights up

Capacity = 0...5% - 1st LED lights up

## 12.2 Battery charger

Only the "eDRAULIC Power Pack Charger" may be used for the lithium-ion batteries.



**NOTE:**

Pay strict attention to the separate operating instructions for the battery charger.

## 12.3 Power supply

The eDRAULIC devices have a specially developed power supply with which the devices can be directly connected to the power grid. The power supply converts the alternating current from the power grid into direct current, which means that it can be used instead of the battery.

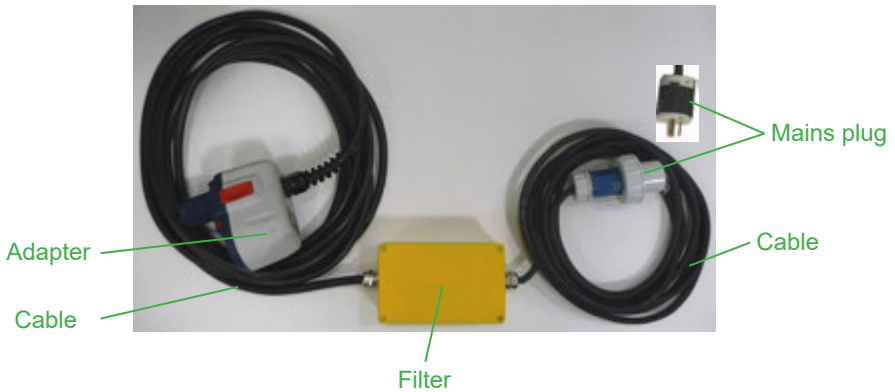

Structure:

There is an adapter on one side of the power supply which can be simply inserted into the connection slot of the devices and locked. The other side has a mains plug. Both are connected by a cable. The mains plug is a Schuko plug with Protection Classification IP 68 or a US plug. The integrated filter is appropriate for the conversion of AC voltage to DC voltage.



**NOTE:**

Pay strict attention to the separate operating instructions for the power supply.

## 12.4 Chain sets

Chain sets are required in order to be able to perform pulling operations with the eDRAULIC spreader (see chapter, "Pulling").

### Suitable chain sets:

for SP 333 E2: KSV 11  
for SP 555 E2: KSV 11  
for SP 777 E2: KSV 11

## 13. Instructions regarding disposal



Please duly dispose of all packaging materials and removed items.

Electrical equipment, accessories and packaging should always be disposed of in an environmentally compatible way.

### Only for EU countries:

Do not dispose of electrical equipment with your household waste!

According to the European Directive 2002/96/EC governing electrical and electronic waste and their application in national legislation, old electrical equipment must be separately collected and recycled in an environmentally compatible manner.

*Please also take into account the notes in the separate operating instructions for the battery chargers.*



## 14. Notes







Please duly dispose of all packaging materials  
and removed items.

---

***HURST*** JAWS OF LIFE, INC  
*A Unit of IDEX Corporation*

711 N. Post Road  
Shelby, NC 28150 USA  
Phone: (704) 487-6961  
Fax: (704) 487-7271  
e-mail: [contacthurst@idexcorp.com](mailto:contacthurst@idexcorp.com)

MADE IN USA