

*Instruction manual for rescue equipment*

**Spreaders**

**STREAMLINE**  
TECHNOLOGY



SP 333



SP 555  
SP 777

271081085 EN  
Edition 11.2018  
*replaces 10.2017*

# Content

# Page

1. Hazard classes	4
2. Product safety	5
3. Proper use	8
4. Description of the functions	9
4.1 <i>Description</i>	9
4.2 <i>Unit in detail</i>	10
4.3 <i>Circuit diagram</i>	11
4.4 <i>Control of the operating movements</i>	11
4.5 <i>Hydraulic supply</i>	11
4.6 <i>Hoses</i>	11
5. Connecting the equipment	12
5.1 <i>General information</i>	12
5.2 <i>Coupling the mono-couplings</i>	12
6. Operation	14
6.1 <i>Preparatory measures</i>	14
6.2 <i>Operating the star grip</i>	14
7. Spreading, pulling, squeezing and peeling	15
7.1 <i>Safety notes</i>	15
7.2 <i>Spreading</i>	16
7.3 <i>Pulling</i>	17
7.4 <i>Squeezing</i>	18
7.5 <i>Peeling</i>	19
8. Dismantling the equipment / deactivation following operation	20
8.1 <i>Spreader</i>	20
8.2 <i>Hydraulic unit</i>	20
8.3 <i>Hoses</i>	20
9. Maintenance and service	20
9.1 <i>Spreader, overall</i>	21
9.2 <i>Protective equipment</i>	21



# **Content**

# **Page**

10. Repairs	22
10.1 <i>General information</i>	22
10.2 <i>Preventative service</i>	22
10.3 <i>Repairs</i>	23
11. Troubleshooting	31
12. Technical data	33
12.1 <i>Peeling</i>	36
12.2 <i>Recommended hydraulic fluid</i>	36
12.3 <i>Operating and storage temperature ranges</i>	36
12.4 <i>Oscillation / vibration</i>	36
13. Notes	37

# 1. Hazard classes

We distinguish between various categories of safety notes. The table below gives you an overview of the assignment of symbols (pictograms) and key words to the specific hazard and possible consequences.

Pictogram	Damage / injury to	Key word	Definition	Consequences
	human	DANGER!	Immediate danger	Death or major injury
		WARNING!	Potentially dangerous situation	Potential death or major injury
		CAUTION!	Less dangerous situation	Minor or slight injury
	device	CAUTION!	Danger of damage to device / environment	Damage to the equipment, damage to the environment, damage to surrounding materials
	-	REMARK	Advice for application and other important / useful information and advice	No injury / damage to persons / environment / equipment



Wear helmet with face protection



Wear safety gloves



Wear safety shoes



Proper recycling



Observe principles of environmental protection



Read and observe operating instructions

## 2. Product safety

HURST products are developed and manufactured in order to guarantee the best performance and quality when used properly.

Operator safety is the most important aspect of the product design.

Moreover, the operating instructions are intended to help the safe use of HURST products.

The generally applicable, legal and other binding regulations pertaining to the prevention of accidents and protection of the environment apply and are to be implemented in addition to the operating instructions.

The equipment may only be operated by persons with appropriate training in the safety aspects of such equipment – otherwise, there is a danger of injury occurring.

We would like to point out to all users that they should read carefully the operating instructions and the instructions contained therein before they use the equipment, and that they should carefully follow such.

We further recommend that a qualified trainer train you in the use of the product.



### **WARNING / CAUTION!**

The operating instructions for the hoses, the accessories and the connected hydraulic equipment must also be observed!























Even if you have already received instructions on how to use the equipment, you should still read the following safety notes through again.









### **WARNING / CAUTION!**

Ensure that the accessories and connected equipment used are suitable for the max. operating pressure!

	<p>Please ensure that no body parts or clothing get stuck between the visibly moving parts (e.g. spreader arms).</p>	<p>It is prohibited to work under load if this load is lifted exclusively by hydraulic equipment. If this work is absolutely imperative, additional mechanical supports must be used.</p>	
	<p>Wear protective clothing, safety helmet with visor, protective gloves</p>	<p>Inspect the equipment before and after use for visible defects or damage</p>	
 	<p>The responsible department is to be informed immediately of any changes (including to the operating behaviour)! If necessary, the equipment is to be deactivated immediately and secured!</p>	<p>Inspect all cables, hoses and screwed connections for leaks and externally visible damage! If necessary, repair immediately! Squirting oil can result in injuries and fires.</p>	

 	<p>In the event of malfunctions, immediately deactivate the equipment and secure it. The malfunction is to be repaired immediately.</p>	<p>Do not carry out any changes (additions or conversions) to the equipment without obtaining the prior approval of HURST.</p>	
 	<p>Observe all safety and danger notes on the equipment and in the operating instructions.</p>	<p>All safety and danger notes on the equipment are to be kept complete in a legible condition.</p>	 
 	<p>Any mode of operation which impairs safety and/or stability of the equipment is forbidden!</p>	<p>Comply with all specified dates or dates specified in the operating instructions pertaining to regular controls / inspections on the equipment.</p>	
 	<p>Safety devices may never be deactivated!</p>	<p>The maximum permitted operating pressure noted on the equipment must not be exceeded.</p>	 
	<p>Before the equipment is switched on/started up, and during its operation, it must be ensured that nobody is endangered by the operation of the equipment.</p>	<p>Only original HURST accessories and spare parts may be used for repairs.</p>	
<p>Please ensure that, when working with this equipment or during transportation of such, you don't get stuck in the looped hoses and trip.</p>	 		
 	<p>When working close to live components and cables, suitable measures must be taken to avoid current transfers or high-voltage transfers to the equipment.</p>	<p>Please note that, when spreading, tearing or breaking can cause falling material, or sudden removal of such can cause it to suddenly catapult off: necessary precautions need to be taken.</p>	
	<p>The build-up of static charge with the potential consequence of spark formation is to be avoided when handling the equipment.</p>	<p>Only touch any broken-off parts wearing protective gloves, since the torn edges can be very sharp.</p>	

	<p>The equipment is filled with a hydraulic fluid. These hydraulic fluids can be dangerous to health if swallowed or their vapours inhaled. Direct contact with the skin is to be avoided for the same reason. Please also note that hydraulic liquids can also have a negative effect on biological systems.</p>	<p>When working with or storing the equipment, ensure that the function and the safety of the equipment are not impaired by the effects of stark external temperatures or that the equipment is damaged in any way. Please note that the equipment can also heat up over a long period of use.</p>	
	<p>Ensure adequate lighting when you are working.</p>	<p>Before transporting the equipment, always ensure that the accessories are positioned such that they cannot cause an accident.</p>	
	<p>Always keep these operating instructions within reach where the equipment is used.</p>	<p>Ensure the proper disposal of all removed parts, left-over oil, left-over hydraulic fluid and packaging materials!</p>	 

The generally applicable, legal and other binding national and international regulations pertaining to the prevention of accidents and protection of the environment apply and are to be implemented in addition to the operating instructions.

## W A R N I N G / C A U T I O N !

The equipment **is to be used exclusively** for the **purpose stated in the operating instructions (see chapter “Proper Use”)**. Any other or further use is **not considered proper use**. The manufacturer / supplier is not liable for any damages resulting from improper use. The user bears sole responsibility for such. Observance of the operating instructions and compliance with the inspection and maintenance conditions are part of the proper use.

Never work when you are overtired or intoxicated!

### 3. Proper use

HURST spreaders are designed especially for rescue services. They are used to release persons trapped as a result of a road accident e.g. by forcing open the car doors (see below Fig. 1) or by squashing other parts of the vehicle. In other catastrophic situations they are used to lift (by spreading) or to displace objects in order to rescue buried or trapped persons, e.g. by concrete components in collapsed houses (see below Fig. 2), and to squash constructional components, e.g. pipes.

In principle, objects can be pulled, spread, squashed or compressed in length.

All objects to be worked on are to be secured using stable supports or substructures.

When lifting loads, additional risks to the operator and/or persons not involved may be posed if the load moves in an uncontrolled manner or if the spreader slips or tips over. When applying the tool and lifting, make sure that there is no danger, if necessary by using additional supports or safety devices.



fig. 1



fig. 2

HURST spreaders and combi tools can also be used under water at a depth of up to 40m (131 ft).



**CAUTION!**

In this case, you must strictly observe any leaks in order to avoid threats to the environment.



**CAUTION!**

All objects which are to be worked on are to be secured using stable supports or substructures.





### **WARNING / CAUTION!**

The following may not be squeezed:

- **live cables**
- **hardened** parts such as springs, spring steels, steering columns and rollers
- explosive bodies such as airbag cartouches



NEVER operate the rescue equipment at a higher operating pressure than that stated in the chapter "Technical data". A higher setting can result in material damage and/or injuries.

HURST rescue equipment may only be used in areas at risk of explosion if an explosion has been prevented by appropriate measures. You must also take into account that sparks may be created, for example by spreading or squashing an object.

When working in areas at risk of explosion, all applicable legal, national and international regulations, standards and safety rules for avoiding explosions must be observed without limitation!

Spare parts and accessories for the rescue tool can be ordered from your authorised HURST-dealer!

## **4. Description of the functions**

### **4.1 Description**

The equipment is designed such that, via a hydraulically activated piston, two equal, opposite spreader arms are symmetrically opened by mechanical joints, thereby spreading objects. Closing the spreader arms is also carried out hydraulically and mechanically by reverse order of the piston.

All spreaders ensure full load-holding function when disconnected from the hydraulic supply (e. g. when being unintentional decoupled; defective hose, and so on).

## 4.2 Unit in detail

SP 333

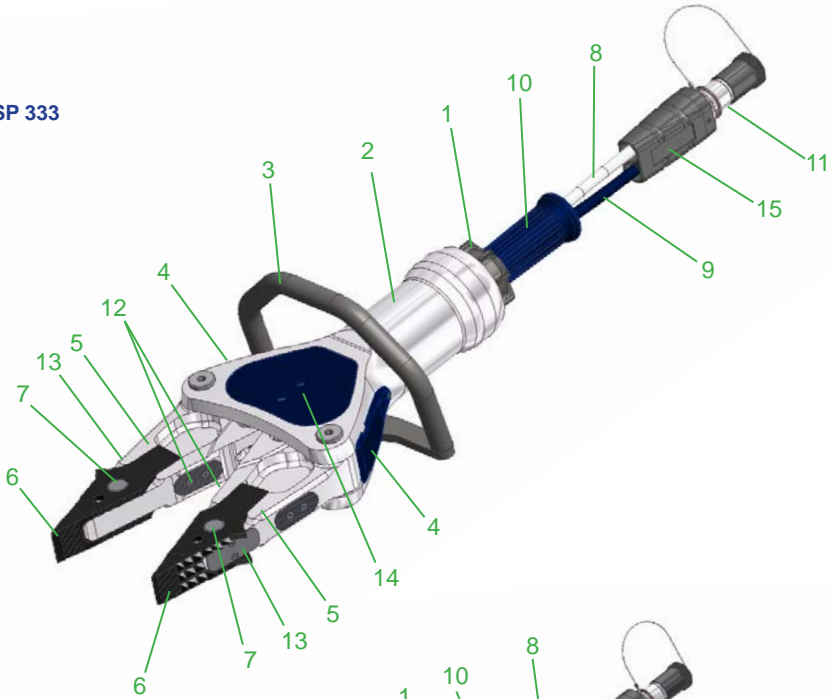

SP 555  
SP 777

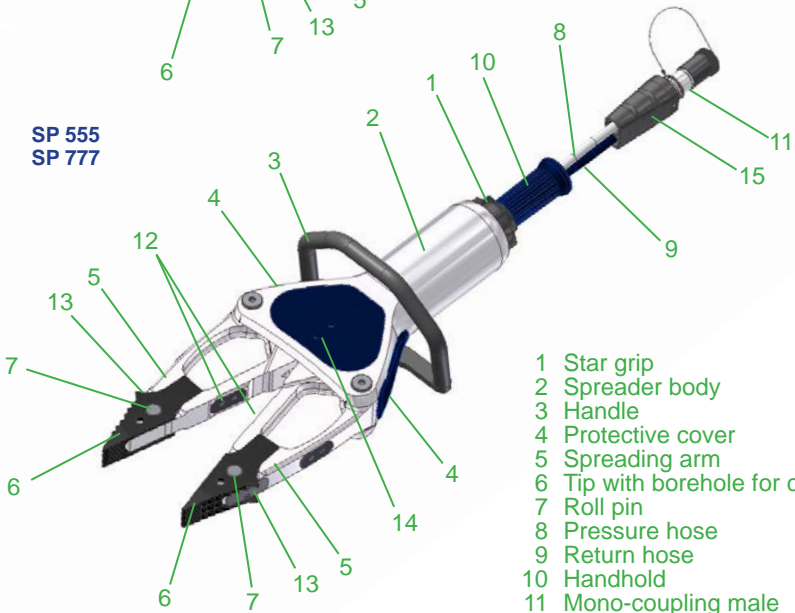

- 1 Star grip
- 2 Spreader body
- 3 Handle
- 4 Protective cover
- 5 Spreading arm
- 6 Tip with borehole for chain set
- 7 Roll pin
- 8 Pressure hose
- 9 Return hose
- 10 Handhold
- 11 Mono-coupling male
- 12 Squeezing device
- 13 Protective plate for spreader arm
- 14 Yoke cover
- 15 Kink-protection

### 4.3 Circuit diagram

To enable comprehension of the function, a simplified hydraulic cylinder of the rescue equipment (A) + hand valve (B) are depicted here.

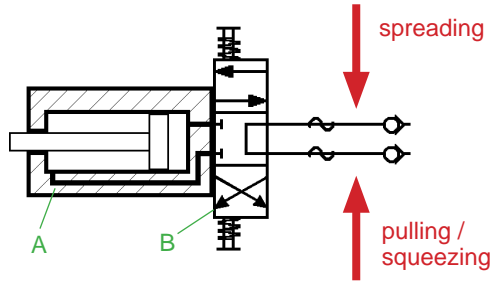

### 4.4 Control of the operating movements

The spreading arms movement is controlled via the star grip of the mounted valve. (see cover, item 1 and, below, figure 3).



fig. 3

star grip

### 4.5 Hydraulic supply

A HURST motor pump or hand pump only may be used to drive the equipment. If the pump unit is a different make, you must make sure that it complies with HURST specifications, otherwise potential dangers may occur which are not the responsibility of HURST.

Ensure in particular that the authorised operating pressure for HURST equipment is not exceeded.



**REMARK:**

Before you use pumps from a different manufacturer, you must contact HURST or an authorised dealer.

### 4.6 Hoses

The pump unit and the rescue tool are connected by hoses.

## 5. Connecting the equipment

### 5.1 General information

There are two short hoses on the side of the equipment: they are connected to the pump unit via two hoses. All hose assemblies are marked with a colour and have couplings to enable unmistakable connection.



#### **WARNING / CAUTION!**



Before connecting the equipment you have to pay attention that **all used components** are suitable to the **max operation pressure of the pump unit!** In the case of doubt you **have to inquire HURST directly!**

### 5.2 Coupling the mono-couplings

The equipment is connected to the hydraulic pump via mono-coupling halves (male and female).

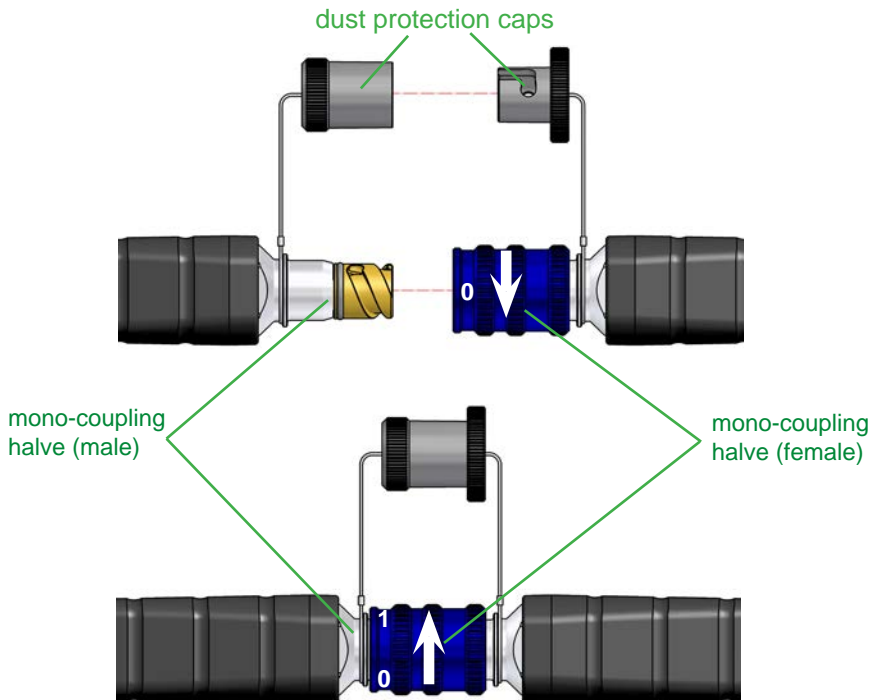

Before coupling, remove dust protection caps, then connect male and female, and turn the locking sleeve of the female to direction „1“ until the locking sleeve locks into place. The connection is now in place and secure. Decoupling is by turning the locking sleeve to direction „0“.  
The equipment can also be coupled under pressure provided the connected equipment is not activated.



**REMARK:**

We **recommend** coupling the coupling halves in a **pressureless** state, when working in areas with low ambient temperature and the usage of extension hose assemblies / hose reels, otherwise decoupling could need very high expenditure of force.

To protect them from dust, the accompanying dust protection caps must be put back on.

**Using the dust protection caps:**

The “A” dust protection caps have two internal pins “B”. The dust protection caps must be placed on the coupling pins in such a way that the pins are guided into the “C” grooves. Fasten the screw up to the limit stop to fix the dust protection caps on the coupling pins.

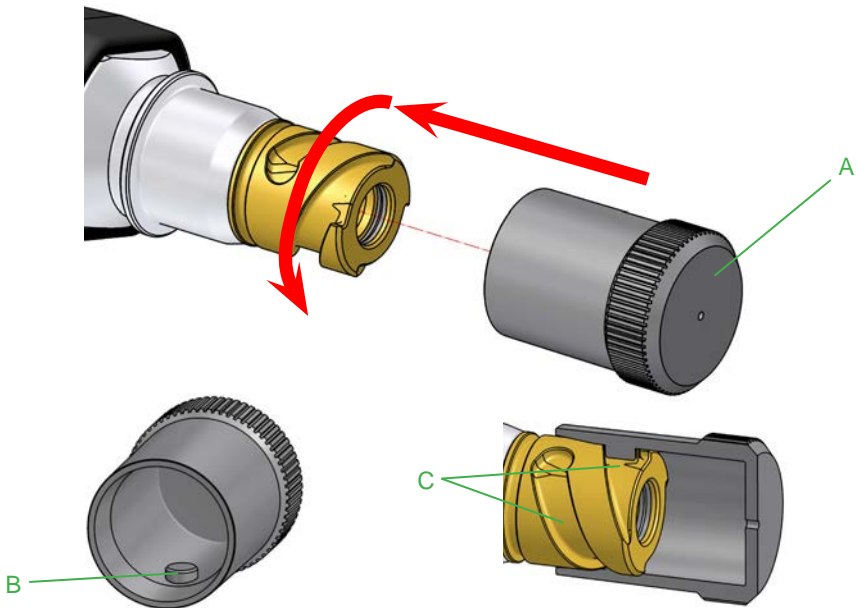

**WARNING/CAUTION!**

The mono-couplings **may not** be **screwed off** the hose assemblies and / or the hose assemblies be **confused!**



## 6. Operation

### 6.1 Preparatory measures

#### 6.1.1 Commissioning

Before commissioning and following repairs, the equipment must be deaerated.

- Connect the equipment to the hydraulic pump (see chapter “Connecting the equipment”).
- Open / close the spreader arms of the equipment without any load at least twice (see chapter “Operation of the star grip”).



**REMARK:**

We recommend that during the deaeration, the attached aggregate for the hydraulic supply should stand on a higher level than the body of the rescue tool.

Recommended procedure for the deaeration of the rescue tool:

- 1.) open and close fully with the spreader arms facing **upwards**.
- 2.) open and close fully with the spreader arms facing **downwards**.
- 3.) open and close fully with the spreader arms facing **upwards**.
- 4.) open and close fully with the spreader arms facing **downwards**.

#### 6.1.2 Inspection of the pump unit

➔ See separate operating instructions for the relevant unit (or for the hand pump).



**REMARK:**

Before each start-up of the hydraulic unit you have to make sure that the actuating valves are set to depressurized circulation.



**REMARK:**

If you use mono-couplings, you can also couple when the hoses are pressurized!

### 6.2 Operating the star grip

Opening the device (  ):

Turn the star grip in a clockwise direction (in the direction of the relevant symbol) and keep in this position.

Closing the device (  ):

Turn the star grip in an counterclockwise direction (in the direction of the relevant symbol) and keep in this position.

**“Dead-man’s” function:**

Following release, the star grip automatically returns to the central position, guaranteeing the full load-holding.

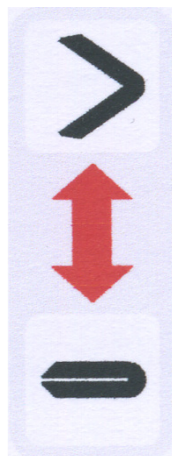

## 7. Spreading, pulling, squeezing and peeling

### 7.1 Safety notes

Before rescue works can commence, the position of the obstacle must be stabilised. You must ensure an adequate substructure and / or adequate support of the object. World-wide, safety guidelines pertaining to the specific country are to be observed and complied with. In the Federal Republic of Germany, regular safety inspections according to the regulations of the Gesetzliche Unfallversicherung (GUV; connoted 'Legal accident insurance') are mandatory.

In the event of a potentially explosive situation, it is not permitted to use motor pumps (danger of the formation of sparks). In such cases, hand pumps are to be used.

The following are to be worn when working with the rescue equipment:

- protective clothing,
- safety helmet with visor or protective goggles,
- protective gloves
- and, if necessary, ear protection

Before activating the rescue equipment, always ensure that there is no danger to persons either involved / uninvolved in the action by the movement of the rescue equipment or by flying fragments. Further avoid unnecessary damage to property belonging to others, objects not involved by the rescue equipment / flying fragments.



**Reaching between the spreader arms is strictly forbidden!**



#### ***WARNING / CAUTION!***

The particular effect of the force of the rescue equipment during operation could cause pieces of the vehicle to break off or fly off, posing a danger to persons. Those not involved in the rescue operation should therefore **keep at a distance appropriate to the situation.**

## 7.2 Spreading

Use the front area of the tips for increasing the gap only. Full spreading capacity can be achieved when approximately half of the grooved area of the tips is used. The greatest force is created in the rear area of the spreading range of the tip (refer to images to follow).



**WARNING / CAUTION!**



The light metal alloy spreader arms may not be damaged.

The spreaders have additional exchangeable plates to protect the arms against physical damage.

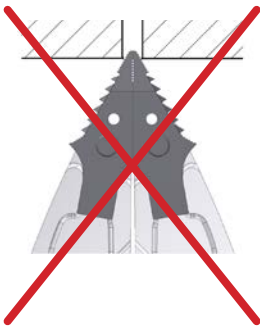
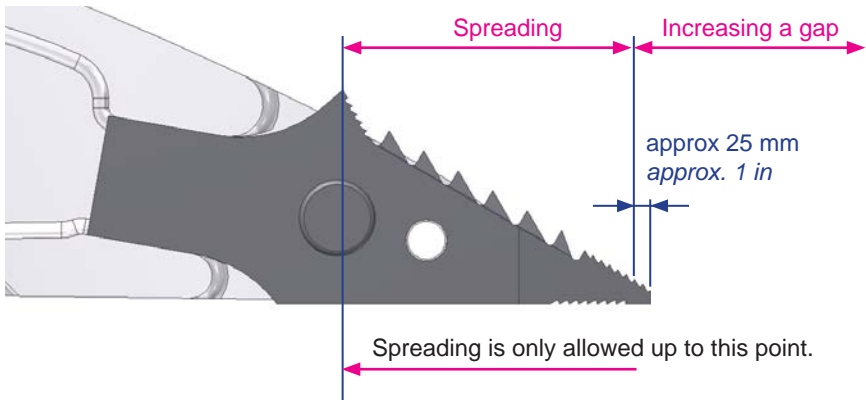

Working surface is too small, tips slip off. Only for increasing the size of a gap (not suitable for spreading)

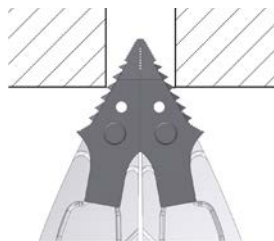

Tips get a safe grip.

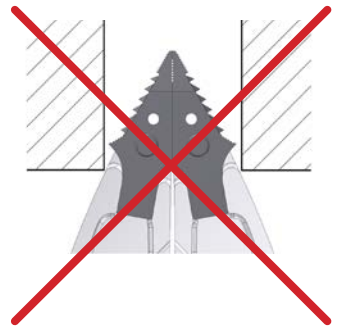

Only work with the tips, so that the spreader is not damaged in the area of the light metal arms.



### 7.3 Pulling

- HURST chain sets are to be used for pulling purposes.
- Before the pulling process can be performed, ensure that the bolt and hook fit correctly to prevent the chain from slipping.
- Only chain sets in perfect condition may be used.
- The pull chains are to be inspected at least once per year by an expert.
- See separate operating instructions for the relevant chain set!



#### **WARNING / CAUTION!**



The light metal alloy spreader arms may not be damaged.

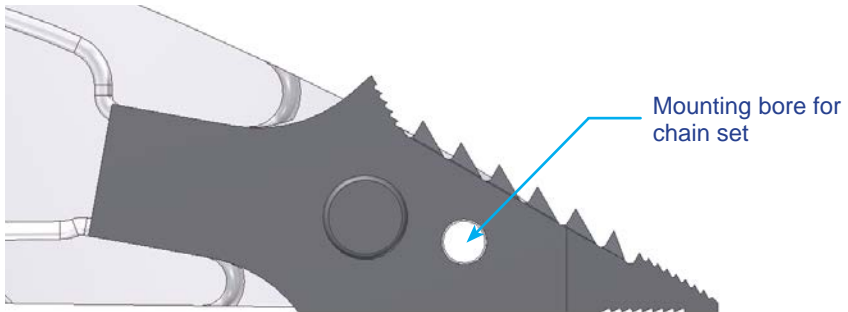

The connecting pieces for HURST chain sets are fastened to the blades using load bolts in holes "A". (see illustration on the right)

#### Permissible chain sets:

for SP 333: KSV 11

for SP 555: KSV 11

for SP 777: KSV 11

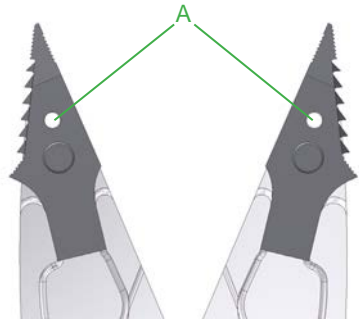

#### **NOTE:**

Also take note of all the instructions and regulations in the separately provided operating instructions for the chain sets.

## 7.4 Squeezing

Squeezing is allowed

- In the area of the tips.

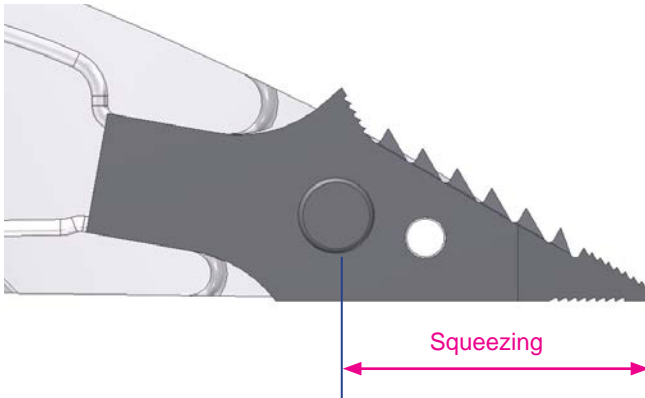

- With the special squeezing plates „A“ in the arms.

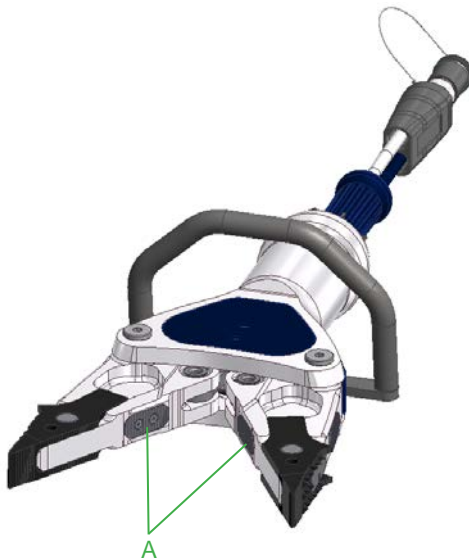

## 7.5 Peeling

It is possible to peel sheet steel with the optional peeling tips of the spreader (max. panel thickness  $t$ , see chapter "Technical Data").

The spreader tip must be replaced with the peeling tip "A", see 10.3.1 Tip changing.

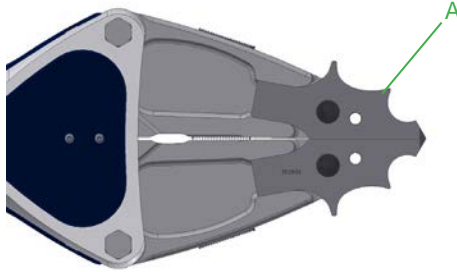

### **WARNING / CAUTION!**

With particularly hard materials, chips may break out in an uncontrolled manner. Please maintain the safety distance!

## 8. Dismantling the equipment / deactivation following operation

### 8.1 Spreader

Once work has been completed, the spreader arms are to be closed so that there is a tip distance of just a few mm. This relieves the hydraulic and mechanical strain on the equipment.

### 8.2 Hydraulic unit

Upon completion of work, the unit must be deactivated.

### 8.3 Hoses

First of all, decouple the pressure hose then the return hose as described in chapter "Connecting the equipment". Ensure that you put the dust protection caps back on to the couplings.

## 9. Maintenance and service

The equipment is subject to very high mechanical stresses. A visual inspection is to be carried out after every use: however, at least one visual inspection is to be carried out annually. These inspections enable the early detection of wear and tear, which means that punctual replacement of this wearing parts prevents breakages from occurring. A function test is also to be carried out every three years or should there be any doubt regarding the safety or reliability of the equipment.

(Please also observe the relevant valid national and international regulations pertaining to service intervals of rescue equipment). In the Federal Republic of Germany, regular safety inspections according to the regulations of the Gesetzlichen Unfallversicherung (GUV; connoted 'Legal accident insurance') are mandatory.



#### **CAUTION!**

Clean off any dirt before controlling the equipment!



#### **WARNING / CAUTION!**

In order to carry out maintenance and repair works, tools appropriate for the job and personal protecting equipment are essential.



## 9.1 Spreader, overall

### Inspections to be carried out:

#### **Visual inspection**

##### *Spreader*

- Opening width of the spreader arms on the tips (see chapter “Technical data”),
- General tightness (leaks),
- Operability of the star grip,
- Existence and stability of handle,
- Labels completely existent and legibly,
- Covers in perfect condition,
- Couplings must be easy to couple,
- Dust protection caps must be available.

##### *Spreader arms*

- Spreader arms free of tears and without any chipped spots or deformations on the surfaces,
- Bolts and retaining rings of the spreader arms must be present and in correct working order,
- Grooving of the tips must be clean and squared, and not have any tears
- Tips existent and locked

##### *Hoses (see also operating instructions for hydraulic hoses)*

- Visual control for visible damage,
- Control for leaks.
- Check date of manufacture (note the replacement period of 10 years).

#### **Function test**

- Opening and closing function flawlessly upon activation of the star grip,
- no suspicious noises.
- no further movement of the spreader arms upon interruption of the valve activation during the process (“dead-man’s” function)

## 9.2 Protective equipment

- Control of the protective equipment on / around the rescue equipment, especially the hand guard of the moveable parts (they must be free of tears!).

# 10. Repairs

## 10.1 General information

Servicing may only be carried out by the manufacturer or personnel trained by the manufacturer and by authorised HURST dealers.

Only HURST spare parts may be used to replace all components (see spare parts list) since special tools, assembly advice, safety aspects, inspections might have to be complied with (see also chapter "Maintenance and Service").

**During assembly, ensure the complete cleanliness of all components, since dirt can damage the rescue equipment!**



### **WARNING / CAUTION!**

Protective clothes must be worn when repairs are being carried out, since parts of the units can also be pressurised in an idle state.



### **REMARK:**

Register your tool on the HURST website. Only then are you entitled to the extended guarantee.



### **REMARK:**

Before you use couplings from a different company, you must contact HURST or an authorised dealer.



### **CAUTION!**

Because HURST rescue equipments are appropriate for highest achievements, only components may be exchanged, which are specified in the spare parts list of the appropriate equipment.

Further components of the equipment may only be exchanged, when:

- you have participated on a appropriate HURST service training.
- you have the explicit permission of the HURST Service department (After inquiry, an examination for the distribution of permission is being carried out. An examination in each individual case is necessary!)

## 10.2 Preventative service

### 10.2.1 Care regulations

The exterior of the equipment is to be cleaned from time to time in order to protect it from external corrosion. Oil is to be applied to the metallic surfaces.

### 10.2.2 Function and load test

If there is any doubt regarding the safety or reliability of the equipment, a function and load test must also be performed.

HURST offers appropriate test equipment to this end.

### 10.2.3 Changing the hydraulic fluid

See the relevant point in the operating instructions for the associated pump (motor pump / hand pump).

## 10.3 Repairs

### 10.3.1 Replacing the plug-on tips

*Procedure:*

1. In order to remove the plug-on tips “G”, you need to push the buttons “J” on both sides of a spreader arm completely and simultaneously and then remove the plug-on tip from the spreader arm by pulling it forwards.
2. Place the new tips onto the arm until they automatically click in place on the spreader arm.

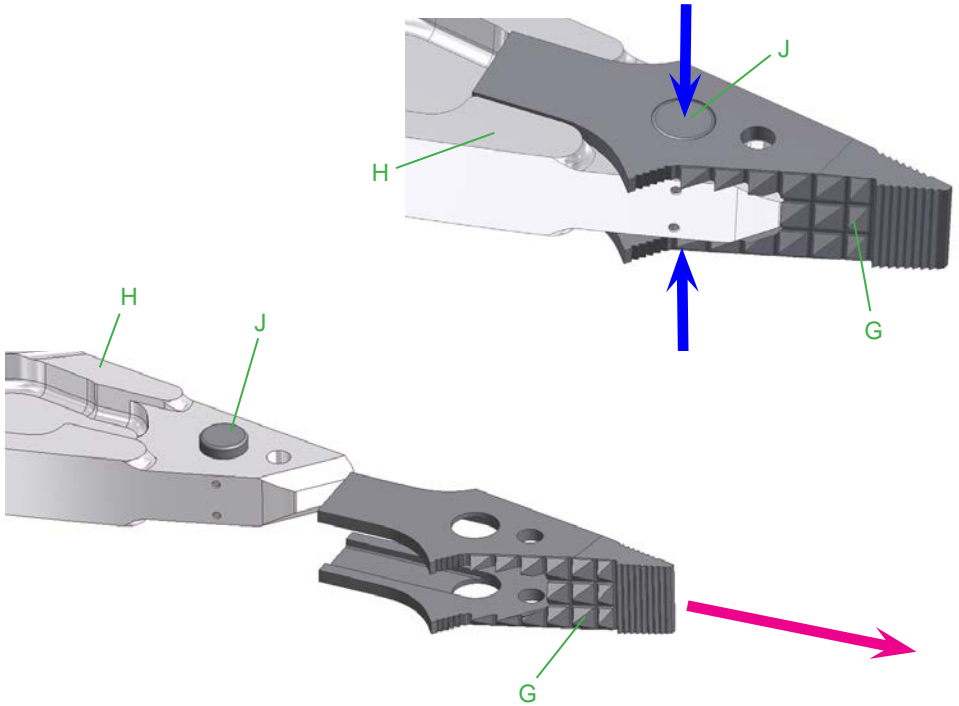

**NOTE:**

Always replace both plug-on tips.

When inserting the new tips, push both buttons “J” until the tip can be slid over them.

After fitting, make sure that both buttons “J” are locked on each arm (that they are back in their original position).

### 10.3.2 Changing or tightening hoses

Hoses of the pressure and/or return pipe leaks or hoses are defective. Tighten the hoses on the safety valve.

(Please note! Observe torque of  $M_A = 40 \text{ Nm!}$ )



#### REMARK.

If you want to change the hoses, you have to dismantle the mono-couplings.



#### CAUTION!

Take care that the port 'T' of the rescue tool is always connected to the port 'T' of the mono-coupling.

#### Procedure:

1. Loosen the 2 screws B in the handle sleeve A (hexagon socket).

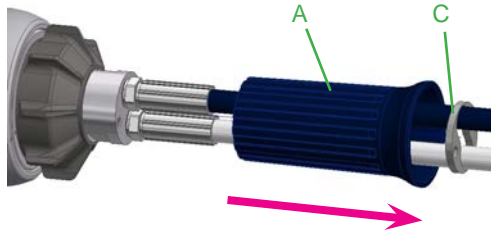
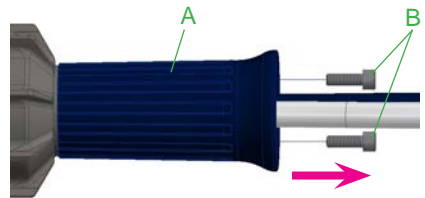

2. Remove handle sleeve A and washer C. Tighten screwed connection. If necessary, renew seals.

3. Dismantle hose D and sealing ring E. (There is no need to carry out this point if the hoses are just being tightened).

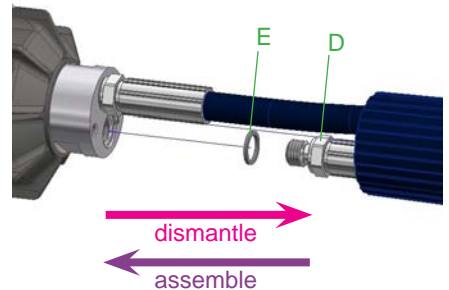

4. Screw the hose with sealing ring back on.
5. Tighten the hose connection on the safety valve. (Please note! Observe the necessary torque of  $M_A = 40 \text{ Nm!}$ ) Secure it with threadlocking fluid (e. g. LOCTITE 243).
6. Then replace handle sleeve, washer and screws, tighten (Torque: 5 Nm) and secure it with threadlocking fluid (e. g. LOCTITE 243).



### 10.3.3 Replacing the handle

1. Close the rescue unit until a gap of only a few mm remains between the tips. Disconnect it from the hydraulic power supply unit and clean thoroughly.
2. Remove the fixing screws "A" and remove the handle "B".

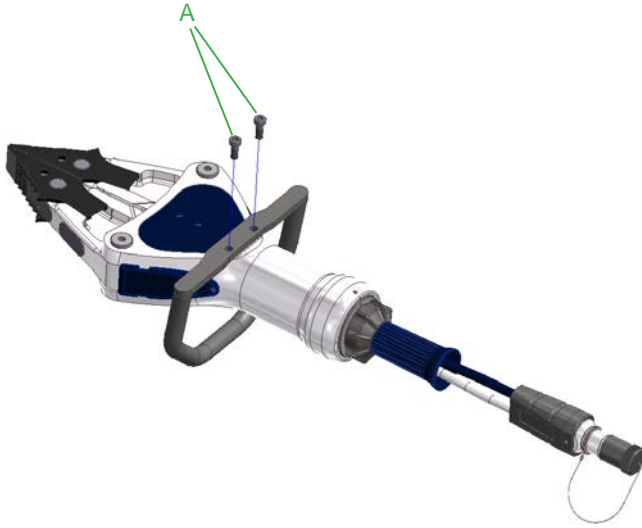

3. Attachment of the handle takes place in the reverse sequence.



**NOTE:**

The torque required can be taken from the spare parts list of your particular unit.

### 10.3.4 Replacing the yoke cover

1. Remove the fixing screws "A" and remove the yoke cover "B".

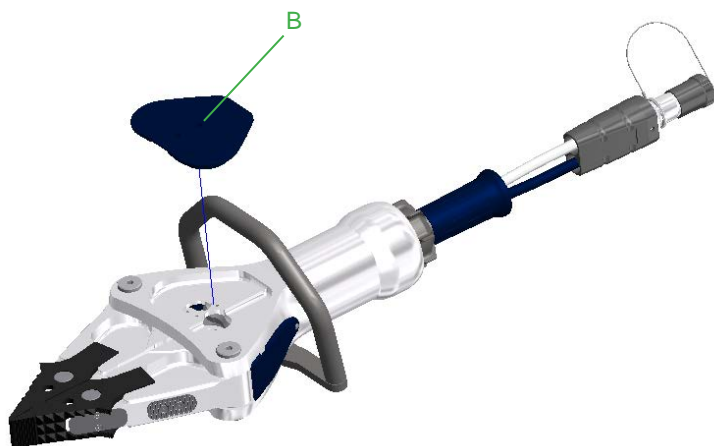
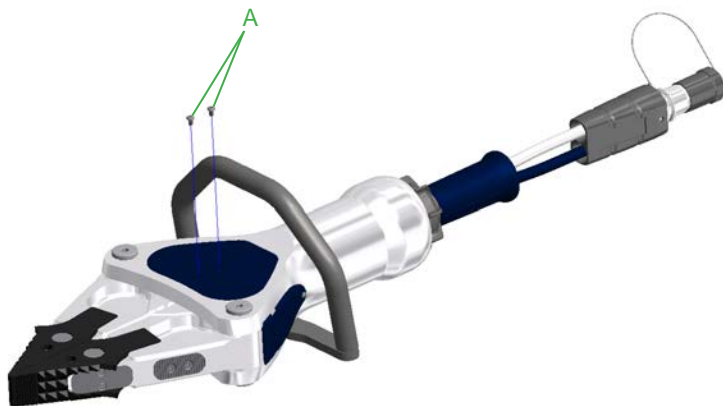

2. Install the new yoke cover.

### 10.3.5 Replacing the squeezing plates

1. Completely open the rescue equipment. Disconnect the equipment from the hydraulic power supply unit and clean thoroughly.
2. Remove the fixing screws "A" and remove the squeezing plates "B".

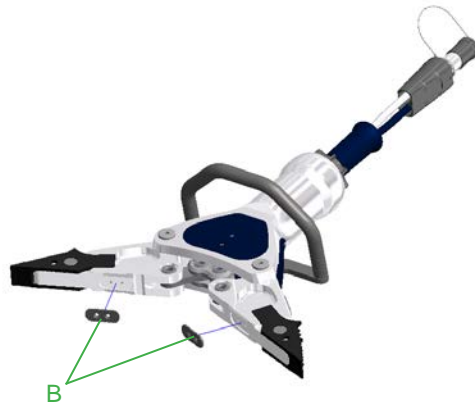

3. Install the new squeezing plates.

### 10.3.6 Replacing the protective plates

1. Close the rescue unit until a gap of only a few mm remains between the tips. Disconnect the equipment from the hydraulic power supply unit and clean thoroughly.
2. Remove the fixing screws "A" and remove the protective plates "B".



3. Install the new protective plates.

### 10.3.7 Replacing the protective covers

1. Remove the fixing screws "A" and remove the protective covers "B" using an appropriate tool.

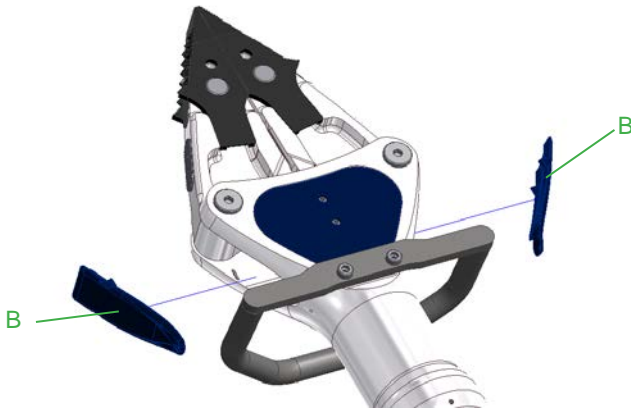
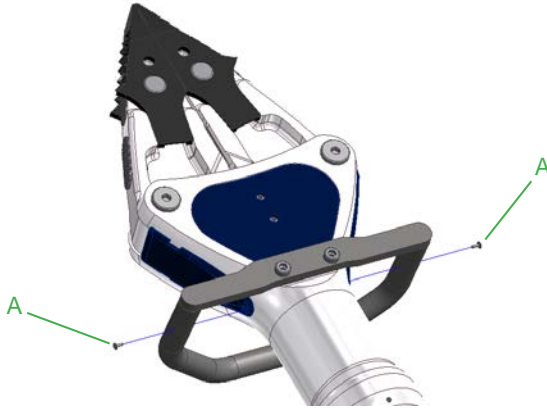

2. Install the new protective covers.

### 10.3.8 Mono-couplings

The mono-couplings must be replaced in the event of:

- external visible damage,
- the locking device not working,
- hydraulic fluid continually leaking in a coupled/uncoupled state.



**WARNING / CAUTION!**



Never repair couplings: they are to be replaced by original HURST parts!

During assembly, tighten the connection nut of the hose assembly with a torque of  $M_A = 40 \text{ Nm}$ .

Procedure:

1. Remove the kink-protection from the couplings.

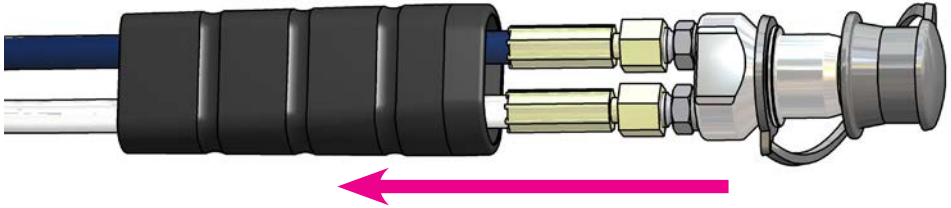

2. Loosen the connection nuts of the hose assembly and remove the coupling.

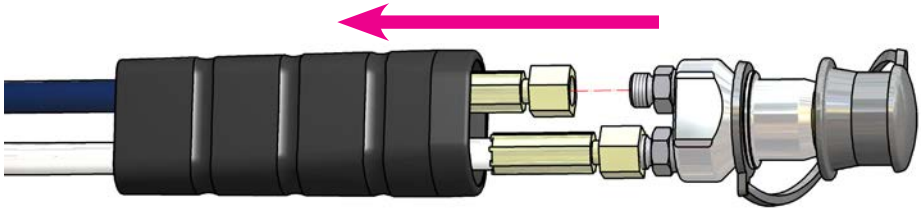

3. Position the new coupling and tighten the connection nuts of the hose assemblies with a torque of  $M_A = 40 \text{ Nm}$  and push the kink-protection of the couplings back on.



**CAUTION!**

Take care that the port 'T' of the rescue tool is always connected to the port 'T' of the mono-coupling.

### 10.3.9 Labels

All damaged and/or illegible labels (safety notices, type plate, etc.) must be renewed.

Procedure:

1. Remove damaged and/or illegible labels.
2. Clean the surfaces using industrial alcohol.
3. Attach new labels.

Ensure that you attach the labels in the right position. If you are no longer sure about this, then please contact your authorised HURST dealer or HURST itself.

## 11. Troubleshooting

<b>Trouble</b>	<b>Control</b>	<b>Cause</b>	<b>Solution</b>
Spreader arms move slowly or jerkily when activated	Are the hoses connected properly?	Air in the hydraulic system	Deaerate pump system
	Does the pump unit work?		
Device doesn't perform at its given power	Check the hydraulic fluid level in the supplying pump	Insufficient hydraulic fluid in the pump	Top up hydraulic fluid, deaerate
Following release, the star grip doesn't return to the central position	Star grip hard to move?	Damage to the torsion spring for reset	Repair by an authorised dealer, by personnel specially trained by HURST, or by HURST itself
		Soiled valve or star grip	
		Defective valve	
		Other mechanical damage (e. g. star grip)	
Hoses cannot be coupled		Pressure too high (e.g. caused by too-high ambient temperature)	Set hydraulic pump to pressureless circulation
		Coupling defective	Coupling needs to be replaced immediately
It is frequently not possible to couple hose assemblies	Control the degree of viscosity and application temperature of the used hydraulic fluid	Hydraulic fluid not adapted to the application situation	Hydraulic fluid must be replaced (see chapter "Recommended Hydraulic fluids")
		Coupling defective	Coupling needs to be replaced immediately
Damages on the surface of the hydraulic hoses		Mechanical damages or contact with aggressive agents	Replace hoses
Hydraulic fluid leaks on the piston rod		Defective rod seal	Repair by an authorised dealer, by personnel specially trained by HURST, or by HURST itself
		Damage to the piston	

<b>Trouble</b>	<b>Control</b>	<b>Cause</b>	<b>Solution</b>
Leak on the handhold	Increase load?	Load increase (e.g. something has fallen onto the part to be lifted, thereby suddenly increasing the load)	Secure the loads and move them by using other tools Move the load somewhere else, where the moving load is lighter Use supporting equipment to move the load.
	Does the pressure set on the pump comply with the maximum permissible pressure on the rescue equipment?	Pressure release in the Rescue tool.	Following the reduction in pressure, no further leak is present. Should, however, there be a further leak on the handhold, immediately deactivate the rescue equipment, and contact an authorised dealer or HURST itself.
	Hoses in handhold loose?	Hoses in handhold not tightened	Tighten hoses.
	Check the connections of the mono-coupling (female)	Supply and return connection of the mono-coupling (female) inverted	Reconnect the hoses of the mono-coupling (female) in the right way
	Leak on the handhold	check the connections of the hoses	hose connection to the couplings interchanged Returnline disabled
Leak in the couplings	Is the coupling damaged?	coupling damaged	Coupling must be replaced immediately



Contact an authorised HURST dealer or the HURST Customer Service Department directly if the malfunctions cannot be rectified.

The address for the HURST Customer Service department is:

**HURST JAWS OF LIFE, INC**  
*A Unit of IDEX Corporation*

711 N. Post Road  
Shelby, NC 28150 USA  
Phone: (704) 487-6961  
Fax: (704) 487-7271  
e-mail: [contacthurst@idex.com](mailto:contacthurst@idex.com)

## 12. Technical data

Since all values are subject to tolerances, minor differences may occur between the data on your equipment and the data in the following schedules!



**NOTE:**

The following tables contain only the technical data required for standard acceptance.

Additional data concerning your unit can be obtained from HURST on request.

<b>type</b>		<b>SP 333</b>
<b>ref. no.</b>		271081000
<b>min. spreading force</b> (25mm / 0.98in. from the tips)	[kN] <i>[lbf.]</i>	42 <i>9442</i>
<b>max. possible spreading force *</b>	[kN] <i>[lbf.]</i>	836 <i>187940</i>
<b>spreading force HSF</b> (according to NFPA)	[kN] <i>[lbf.]</i>	63 <i>14163</i>
<b>spreading force LSF</b> (according to NFPA)	[kN] <i>[lbf.]</i>	39 <i>8768</i>
<b>max. spreading distance</b>	[mm] <i>[in.]</i>	600 <i>23.6</i>
<b>max. pulling force</b> (with appropriate chain set)	[kN] <i>[lbf.]</i>	56 <i>12589</i>
<b>pulling distance</b> (with appropriate chain set)	[mm] <i>[in.]</i>	440 <i>17.3</i>
<b>pulling force HPF</b> (according to NFPA)	[kN] <i>[lbf.]</i>	43 <i>9667</i>
<b>pulling force LPF</b> (according to NFPA)	[kN] <i>[lbf.]</i>	23 <i>5171</i>
<b>dimensions</b> l x w x h (w/o connection hoses)	[mm] <i>[in.]</i>	723 x 285 x 202 <i>28.5 x 11.2 x 7.95</i>
<b>weight incl. hydraulic fluid</b>	[kg] <i>[lbs.]</i>	13,4 <i>29.5</i>
<b>max. operating pressure **</b>	[Mpa] <i>[psi.]</i>	70 <i>10000</i>
<b>min. needed volume of hydraulic fluid ***</b>	[cm <sup>3</sup> ] <i>[gal.-US]</i>	150 <i>0.04</i>
<b>coupling system</b>	mono-coupling	
<b>classification acc. to DIN EN 13204</b>	AS 42/600 - 13,4	

\* Computed value

\*\* 1 MPa = 10 bar

\*\*\* Necessary volume of hydraulic fluid in the hydraulic unit to operate the unit (differential volume on piston / rod side)

<b>type</b>		<b>SP 555</b>	<b>SP 777</b>
<b>ref. no.</b>		271086000	271087000
<b>min. spreading force</b> (25mm / 0.98in. from the tips)	[kN] <a href="#">[lbf.]</a>	52 <a href="#">11690</a>	63 <a href="#">14160</a>
<b>max. possible spreading force *</b>	[kN] <a href="#">[lbf.]</a>	658 <a href="#">147924</a>	600 <a href="#">134900</a>
<b>spreading force HSF</b> (according to NFPA)	[kN] <a href="#">[lbf.]</a>	72 <a href="#">16186</a>	85 <a href="#">19110</a>
<b>spreading force LSF</b> (according to NFPA)	[kN] <a href="#">[lbf.]</a>	49 <a href="#">11016</a>	59 <a href="#">13260</a>
<b>max. spreading distance</b>	[mm] <a href="#">[in.]</a>	730 <a href="#">28.7</a>	813 <a href="#">32.0</a>
<b>max. pulling force</b> (with appropriate chain set)	[kN] <a href="#">[lbf.]</a>	58 <a href="#">13039</a>	60 <a href="#">13490</a>
<b>pulling distance</b> (with appropriate chain set)	[mm] <a href="#">[in.]</a>	569 <a href="#">22.4</a>	655 <a href="#">25.8</a>
<b>pulling force HPF</b> (according to NFPA)	[kN] <a href="#">[lbf.]</a>	46 <a href="#">10341</a>	49 <a href="#">11016</a>
<b>pulling force LPF</b> (according to NFPA)	[kN] <a href="#">[lbf.]</a>	28 <a href="#">6295</a>	30 <a href="#">6744</a>
<b>dimensions</b> l x w x h (w/o connection hoses)	[mm] <a href="#">[in.]</a>	823 x 285 x 202 <a href="#">32.4 x 11.2 x 7.95</a>	898 x 308 x 202 <a href="#">35.4 x 12.1 x 7.95</a>
<b>weight incl. hydraulic fluid</b>	[kg] <a href="#">[lbs.]</a>	16,2 <a href="#">35.7</a>	19,7 <a href="#">43.4</a>
<b>max. operating pressure **</b>	[Mpa] <a href="#">[psi.]</a>	70 <a href="#">10000</a>	70 <a href="#">10000</a>
<b>min. needed volume of hydraulic fluid ***</b>	[cm <sup>3</sup> ] <a href="#">[gal.-US]</a>	240 <a href="#">0.07</a>	385 <a href="#">0.10</a>
<b>coupling system</b>		mono-coupling	mono-coupling
<b>classification acc. to DIN EN 13204</b>		AS 52/730 - 16,2	BS 63/813 - 19,7

\* Computed value

\*\* 1 MPa = 10 bar

\*\*\* Necessary volume of hydraulic fluid in the hydraulic unit to operate the unit  
(differential volume on piston / rod side)

## 12.1 Peeling

Device type		SP 333	SP 555	SP 777
Max. sheet steel thickness “t”	[mm] [in.]	2 0.08	3 0.12	4 0.16
Max. possible opening	[mm] [in.]	510 20.1	640 25.2	725 28.5

## 12.2 Recommended hydraulic fluid

### Hydraulic fluid for HURST hydraulic equipment:

*Mineral oil DIN ISO 6743-4 and others*

	Oil temperature range	Oil code	Viscosity rating	Remarks
A	-20 .... +55°C -4.0 .... +131°F	HM 10	VG 10	

recommended viscosity range: 10...200 mm<sup>2</sup>/s (10...200 cSt.)

Supplied with HM 10 DIN ISO 6743-4.



### **CAUTION!**

Before using hydraulic fluids, which do not correspond to the above-mentioned specifications and/or are not purchased from HURST, you have to contact HURST itself!

## 12.3 Operating and storage temperature ranges

<b>Operating temperature</b>	[°C] / [°F]	-20 ... +55	-4 ... +131
<b>Ambient temperature</b> (device in operation)	[°C] / [°F]	-25 ... +45	-13 ... +113
<b>Storage temperature</b> (device not in operation)	[°C] / [°F]	-30 ... +60	-22 ... +140

## 12.4 Oscillation / vibration

The total oscillation value / vibration value to which the upper limbs are exposed, is usually below 2.5 m/s<sup>2</sup>.

Higher values may be measured for short periods as a result of interaction with the materials to be processed.

## 13. Notes







Please dispose all packaging materials and dismantled parts properly

---

***HURST*** JAWS OF LIFE, INC  
*A Unit of IDEX Corporation*

711 N. Post Road  
Shelby, NC 28150 USA  
Phone: (704) 487-6961  
Fax: (704) 487-7271  
e-mail: [contacthurst@idexcorp.com](mailto:contacthurst@idexcorp.com)

MADE IN USA